

模板机-触摸屏 E2

Template machine - Touch screen E2

2019-01

前 言

欢迎您使用本公司的特种缝纫机控制系统。

请您仔细阅读本操作手册，以确保正确的操作、使用特种缝纫机，请按照本手册内注明的方式进行操作，否则，如违规操作所造成损失本公司不承担责任。此外，请将本用户手册妥善保存在安全地点，以便随时查阅。若发生故障须由本公司指定的技术人员或专业人员进行维修。

Foreword





Thank you for using our Computerized Control System for Special Sewing Machine.

It is appreciated that you do read this manual carefully, so that you can operate the machine correctly and effectively. If the user operates the machine contrary to regulations herein, thus causes loss to user or third party, we will not take any responsibility. Besides that, you should keep this manual ready for future use. For any fault or problem of machine, please ask the professionals or the technicians authorized by us for repair service.



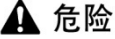
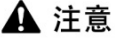







安全注意事项





1. 安全操作的标志及含义













使用说明书及产品所使用的安全标志是为了让您正确安全的使用产品，防止您及其他人受到伤害。标志的图案和含义如下：

 危险	如果忽视此标记而进行错误的操作，会导致人员的重伤或死亡。
 注意	如果忽视此标记而进行错误的操作，会导致人员的受伤和设备的损坏。
	该符号表示“应注意事项”。三角中的图案表示必须要注意的内容。（例如左边的图案表示：“当心受伤”）
	该符号表示“禁止”
	该符号表示“必须”。圆圈中的图案表示必须要做的内容。（例如左边的图案表示“必须接地”）

2. 安全注意事项

 危险	
	打开控制箱时，先关闭电源开关并将电源插头从插座上拔下后，等待至少 5 分钟后，再打开控制箱盖。触摸带有高电压的区域会造成人员受伤。
 注意	
使用环境	
	应避免在强电气干扰源（如高频焊机）的附近使用本缝纫机。 强电气干扰源可能会影响缝纫机的正常操作。
	电源电压的波动应该在额定电压的±10%以内的环境下使用。 电压大幅度的波动会影响缝纫机的正常操作，需配备稳压器。
	环境温度应在 0℃~45℃ 的范围内使用。 低温或高温会影响缝纫机的正常操作。
	相对湿度应在 35%~85% 的范围内，并且设备内不会形成结露的环境下使用。干燥、潮湿或结露的环境会影响缝纫机的正确操作。
	压缩空气的供气量应大于缝纫机所要求的总耗气量。压缩空气的供气量不足会导致缝纫机的动作不正常。
	万一发生雷电暴风雨时，关闭电源开关，并将电源插头从插座上拔下。雷电可能会影响缝纫机的正确操作。
安装	
	请让受过培训的技术人员来安装缝纫机。
	安装完成前，请不要连接电源。 如果误按启动开关，缝纫机动作会导致受伤。





	缝纫机头倒下或竖起时，请用双手操作。不要用力压缝纫机。 如缝纫机失去平衡，缝纫机滑落到地上会造成受伤或机器损坏。
	必须接地。 接驳地线不牢固，是造成触电或误动作的原因。
	所有电缆应固定在离活动部件至少 25mm 以外处。另外，不要过度弯曲或用卡钉固定得过紧。 会引起火灾或触电的危险。
	请在机头上安装安全罩壳。

缝纫	
	本缝纫机仅限于接受过安全操作培训的人员使用。
	本缝纫机不能用于除缝纫外的任何用途。
	使用缝纫机时必须戴上保护眼镜。 如果不戴保护眼镜，断针时机针折断部分可能会弹入眼睛造成伤害。
	发生下列情况时，请立即切断电源。否则误按下启动开关时，会导致受伤。 1. 机针穿线时 2. 更换机针时 3. 缝纫机不使用或人离开缝纫机时
	缝纫过程中，不要触摸任何运动部件或将物件靠在运动部件上，因为这会导致人员受伤或缝纫机损坏。
	如果缝纫机操作中发生误动作，或听到异常的噪声或闻到异常的气味，应立即切断电源。然后请与购买商店或受过培训的技术人员联系。
	如果缝纫机出现故障，请与购买商店或受过培训的技术人员联系。
维护和检查	
	只有经过训练的技术人员才能进行缝纫机的维修、保养和检查。
	与电气有关的维修、保养和检查请及时与电控厂家的专业人员进行联系。
	发生下列情况时，请关闭电源并拔下电源插头。否则误按启动开关时，会导致受伤。 1. 检查、调整和维修 2. 更换弯针、切刀等易损零部件
	在检查、调整和修理任何使用气动设备之前，请先断开气源，并等压力表指针下降到“0”为止。
	在必须接上电源开关和气源开关进行调整时，务必十分小心遵守所有的安全注意事项。
	未经授权而对缝纫机进行改装而引起的缝纫机损坏不在保修范围内。













Safety Matters for Attention



1. Signs & Definitions of Safety Marks







This User’s Manual and the Safety Marks printed on the products are to enable you to use this product correctly so as to be away from personal injury. The signs and definitions of Marks are shown in below:







 Danger	The incorrect operation due to negligence will cause the serious personal injury or even death.
 Caution	The incorrect operation due to negligence will cause the personal injury and the damage of mechanism.
	This kind of marks is “Matters for Attention”, and the figure inside the triangle is the content for attention. (Exp. The left figure is “Watch Your Hand!”)
	This kind of mark is “Forbidden”.
	This kind of mark (Black Circle) means “Must”. The figure in the circle is the contents that have to be done. (Exp. The left figure is “Ground!”)

2. Safety Matters for Attention

 Danger	
	For opening the control box, please turn off the power and take away the plug from socket firstly, and then wait for at least 5 minutes before opening the control box. Touching the part with high voltage will cause the personal injury.
 Caution	
Usage Environment	
	Try not to use this sewing machine near the sources of strong disturbance like high-frequency welding machine. The source of strong disturbance will affect the normal operation of the sewing machine.
	The voltage fluctuation shall be within 10% of the rated voltage. The large fluctuation of voltage will affect the normal operations of sewing machine, Therefore a voltage regulator is needed in that situation.
	Working temperature: 0°C~45°C. The operation of the sewing machine will be affected by environment with temperature beyond the above range.
	Relative Humidity: 35%~85%(No dew inside the machine), or the operation of sewing machine will be affected.
	The supply of compressed gas shall be over the consumption required by the sewing machine. The insufficient supply of compressed gas will lead to the abnormal action of sewing machine.
	In case of thunder, lightning or storm, please turn off the power and pull plug out the socket. Because these weather factors will have influence on the operation of sewing machine
Installation	
	Please ask the trained technicians to install the sewing machine.
	Don’t connect machine to power supply until the installation is finished. Otherwise the action of sewing machine may cause personal injury once the start switch is pressed at that situation by mistake.
	When you tilt or erect the head of sewing machine, please use both of your hands in that operation. And never press the sewing machine with strength.

	If the sewing machine loses its balance, it will fall into floor thus causes the personal injury or mechanical damage.
	Grounding is a must. If the grounding cable is not fixed, it may cause the electric-shock and mistake-operation of machine
	The entire cables shall be fixed with a distance at 25mm away from the moving component at least. By the way, don't excessively bend or tightly fixed the cable with nails or clamps, or it may cause the fire or electric shock.
	Please add security cover on the machine head.

Sewing	
	This sewing machine can only be used by the trained staff.
	This sewing machine has no other usages but the sewing.
	When operating the sewing machine, please remember to put on the glasses. Otherwise, the broken needle will cause the personal injury in case the needle is broken.
	At following circumstances, please cut off the power at once so as to avoid the personal injury caused by the mistake operation of start switch: 1. Threading on needles; 2. Replacement of needles; 3. The sewing machine is left unused or beyond supervision
	At working, don't touch or lean anything on the moving components, because both of the above behaviors will cause the personal injury or the damage of the sewing machine.
	During working, if the mistake operation happens or the abnormal noise or smell is found at the sewing machine, user shall cut off the power at once, and then contact the trained technicians or the supplier of that machine for solution.
	For any trouble, please contact the trained technicians or the supplier of that machine.

Maintenance & Inspection	
	Only can the trained technicians perform the repair, maintenance and inspection of this sewing machine.
	For the repair, maintenance and inspection of the electrical component, please contact the professionals at the manufacturer of control system in time.
	At following circumstances, please cut off the power and pull off the plug at once so as to avoid the personal injury caused by the mis-operation of start switch: 1. Repair, adjustment and inspection ; 2. Replacement of the component like curve needle, knife and so on
	Before the inspection, adjustment or repair of any gas-driven devices, user shall cut off the gas supply till the pressure indicator falls to 0.
	When adjusting the devices needing the power supply and gas supply, users can't be too careful to follow this Safety Matters for Attention.
	If the sewing machine damages due to the unauthorized modification, our company will not be responsible for it.

目录

1 概要说明.....	1
1.1 概述.....	1
1.2 功能和指标参数.....	2
1.3 主界面.....	3
1.4 操作方式.....	4
1.5 快速缝制入门.....	5
2 花样选择界面.....	8
2.1 花样预览.....	10
2.2 检测功能.....	11
2.2.1 输入信号检测.....	12
2.2.2 输出信号检测.....	13
2.2.3 主轴电机校正.....	14
2.2.4 转速测试.....	15
2.2.5 XY 电机原点检测.....	16
2.2.6 中压脚原点检测.....	18
2.2.7 剪线电机检测.....	20
2.2.8 连续运转.....	22
2.2.9 抓线电机检测.....	22
2.2.10 RFID 设置.....	23
2.2.11 扩展功能检测.....	24
2.2.12 多功能 IO 检测.....	26
2.2.13 触摸屏校正.....	27
2.2.14 液晶检测.....	28
3 花样缝制界面.....	29
3.1 中压脚功能.....	31
3.2 修改起缝点.....	33
4 花样管理.....	35
4.1 功能键.....	36
5 设置.....	40
5.1 版本查询.....	41
5.2 传输与升级.....	41
5.3 伺服参数.....	42
5.4 维护与保养设置.....	44
5.5 参数备份与还原.....	44
5.6 面板设置.....	45
5.7 U 参数更改方法.....	47
5.8 已修改参数.....	50
5.9 参数定制.....	51
5.10 用户参数表.....	51
6 绕线.....	60
7 信息.....	61

7.1 分期密码.....	61
7.2 穿线示意.....	69
7.3 打卡.....	70
7.4 生产管理参数.....	70
7.5 加减计数器.....	70
7.6 运转记录.....	71
7.7 报警记录.....	72
7.8 错误上报.....	72
8 附录 1.....	74
8.1 报警信息一览表.....	74
8.2 信息提示一览表.....	76
9 附录 2.....	81
9.1 电控箱连接示意图.....	81
9.2 操作箱示意图.....	82
9.3 系统框图.....	83

Contents

1 General Introduction.....	1
1.1 General.....	1
1.2 Functions & Specifications.....	2
1.3 The main interface.....	3
1.4 Operation Method.....	4
1.5 Quick introduction to sewing.....	5
2 Pattern selection interface.....	8
2.1 Pattern preview.....	10
2.2 Test Mode.....	11
2.2.1 Input signal detection.....	12
2.2.2 Output signal detection.....	13
2.2.3 Spindle motor correction.....	14
2.2.4 Speed test.....	15
2.2.5 XY motor origin detection.....	16
2.2.6 Origin detection of middle pressure foot.....	19
2.2.7 Shear line motor detection.....	21
2.2.8 Continuous operation.....	24
2.2.9 Catch wire motor detection.....	25
2.2.10 RFID setting.....	26
2.2.11 Extended function detection.....	26
2.2.12 Multi-function IO detection.....	28
2.2.13 Touch screen correction.....	30
2.2.14 LCD test.....	31
3 Pattern sewing interface.....	32
3.1 Medium pressure foot function.....	34
3.2 Modify the seam.....	36
4 Design management.....	39
4.1 The function keys.....	40
5 Setting.....	44
5.1 Version of the query.....	45
5.2 Transmission and upgrade.....	45
5.3 Servo parameters.....	46
5.4 Maintenance and maintenance Settings.....	48
5.5 Parameter backup and restore.....	48
5.6 Panel Settings.....	50
5.7 U Parameter change method.....	51
5.8 Modified parameter.....	54
5.9 Parameters of the custom.....	55
5.10 User parameter list.....	55
6 Winding.....	70
7 information.....	71
7.1 Periodical Password.....	71

7.2 Threading motioned.....	79
7.3 Clock in.....	80
7.4 Production management parameters.....	80
7.5 add-subtract counter.....	80
7.6 Run Note.....	81
7.7 The alarm record.....	82
7.8 Error reporting.....	82
8 Appendix 1.....	84
8.1 List of alarm information.....	84
8.2 List of information tips.....	87
9 Appendix 2.....	93
9.1 Connection diagram of electric cabinet.....	93
9.2 Schematic diagram of operation box.....	94
9.3 Control System Diagram.....	95

1 概要说明

1.1 概述

全自动模板机系列工业缝纫机电脑控制系统，主轴电机采用具有世界先进水平的交流伺服控制技术驱动，具有力矩大、效率高、车速稳定和噪音低等特点。操作面板设计多样化可满足不同客户的配套要求；系统采用德国式结构设计，安装和维修方便快捷，系统控制软件可通过远程通讯升级，方便用户不断提高产品性能。

1.2 功能和指标参数

序号	控制器型号	全自动模板机
1	缝制范围	X(左右)方向 Y (前后方向) 1300 x 800
2	最高缝纫速度	3200rpm (针距不大于 3.0mm 时)
3	缝迹长度	0.1~12.7mm (最小分辨率 0.05mm)
4	压脚送布	间断送布 (伺服驱动方式)
5	针杆行程	41.2mm
6	使用机针	DP×5、DP×17
7	外压脚上升量	最大 25mm (气动式最大 30mm)
8	中压脚行程	标准 4mm (0~10mm)
9	中压脚上升量	20mm
10	旋梭	1.6 倍旋梭
11	花样数据的记忆	U 盘
12	暂停功能	在缝制途中可以让缝纫机停止
13	放大、缩小功能	可以选择缝迹缝制花样时, 可以独立地放大缩小 X、Y 轴。 1%~400% (0.1%单位)
14	放大、缩小方式	增减缝迹长度方式
15	缝纫速度限制	200~3200rpm (100rpm 单位)
16	花样选择功能	花样号选择方式
17	底线计数器	加数计数/减数计数方式 (0~65535)
18	缝制计数器	加数计数/减数计数方式 (0~9999)
19	第二原点的设定	用微动开关可以把缝制后的针位置移动到缝制范围内的任意位置 设定为第 2 原点。
20	缝纫机马达	伺服马达
21	针杆上死点停止功能	缝制后, 可以让针杆返回到上死点位置。
22	额定功率	600W
23	使用温度范围	0℃~45℃
24	使用湿度范围	35%~85% (无结露)
25	电源电压	AC 220V ± 10%; 50/60Hz

※产品执行标准: QCYXDK0004—2016《工业缝纫机计算机控制系统》。

1.3 主界面

开机后将直接进入【花样选择】界面，单击可进入【花样缝制】界面。

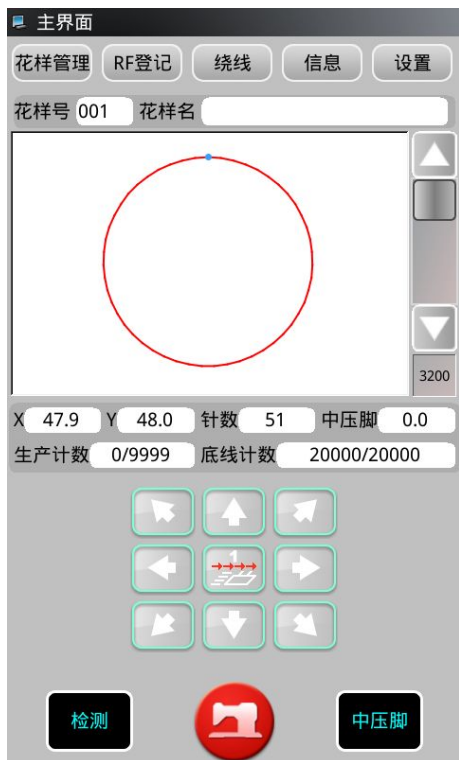

花样选择界面

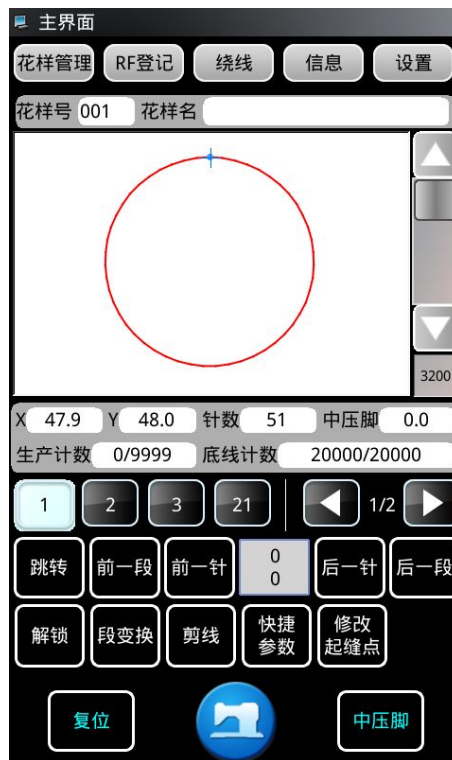

花样缝制界面

1.4 操作方式

触摸屏操作面板采用了业界先进的触摸操作技术，集合踏板的压框、启动和急停开关功能的实体按键，友好的界面以及便捷的操控都给用户的日常使用带来革新性的变化。用户可以使用手指或者其他物体点触屏幕，完成相应的操作。用户在使用过程中应该注意避免使用尖锐的物体触碰屏幕，以免对触摸屏造成永久性损伤

1.5 快速缝制入门

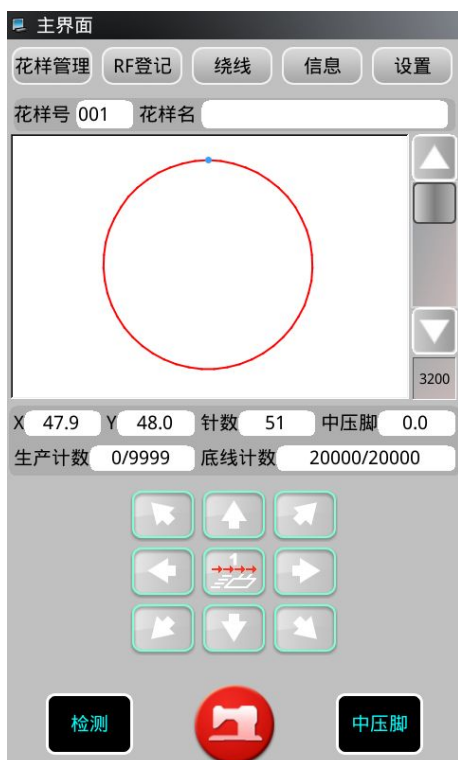

开机将直接进入【花样选择】界面。

单击【花样选择】界面的“花样管理”键 ，进入【读取花样】界面。



在【读取花样】界面，可选择想要缝制的花样。

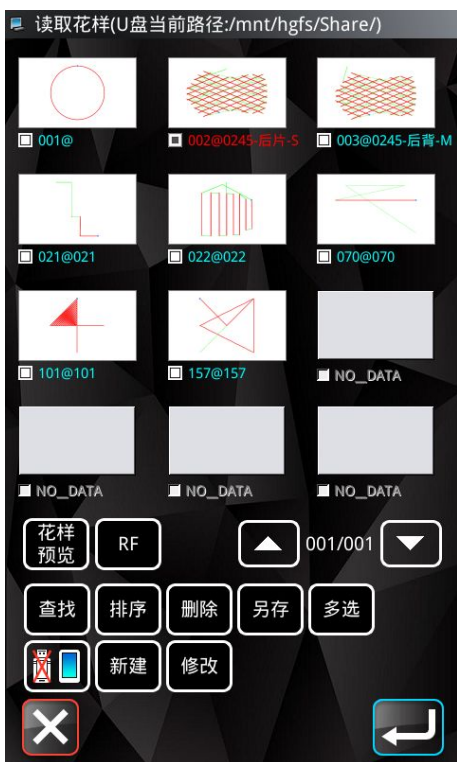

在【读取花样】界面单击想要缝制的花样，选中该花样。



单击“回车”，确认花样并自动返回到【花样选择】界面。

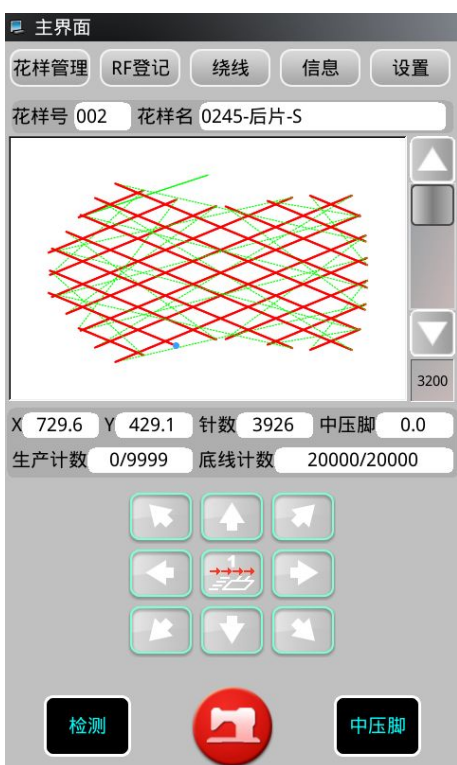

在【花样选择】界面，单击可进入【花样缝制】界面。

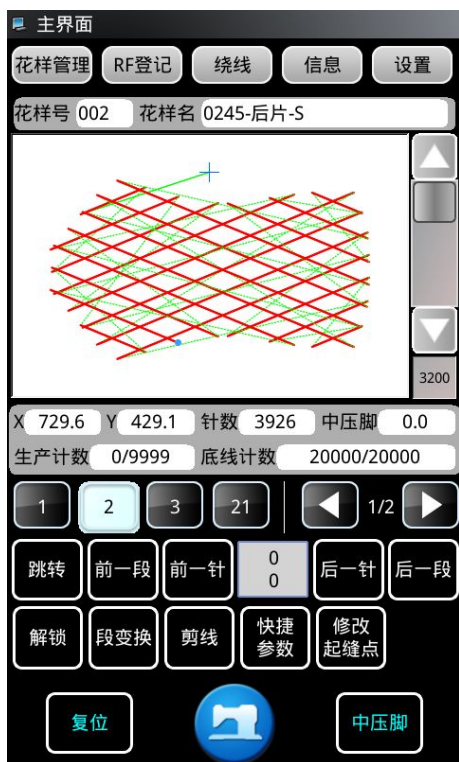

在【花样缝制】界面，可对花样参数进行设置。

花样参数设置完成后，将对应模板放到位，先按下操作头上“压框”按钮，再按一下“启动”按钮，确认起缝点位置无误后，按第二下“启动”按钮，开始缝制。

2 花样选择界面

开机后将直接进入【花样选择】界面，显示花样基本参数。

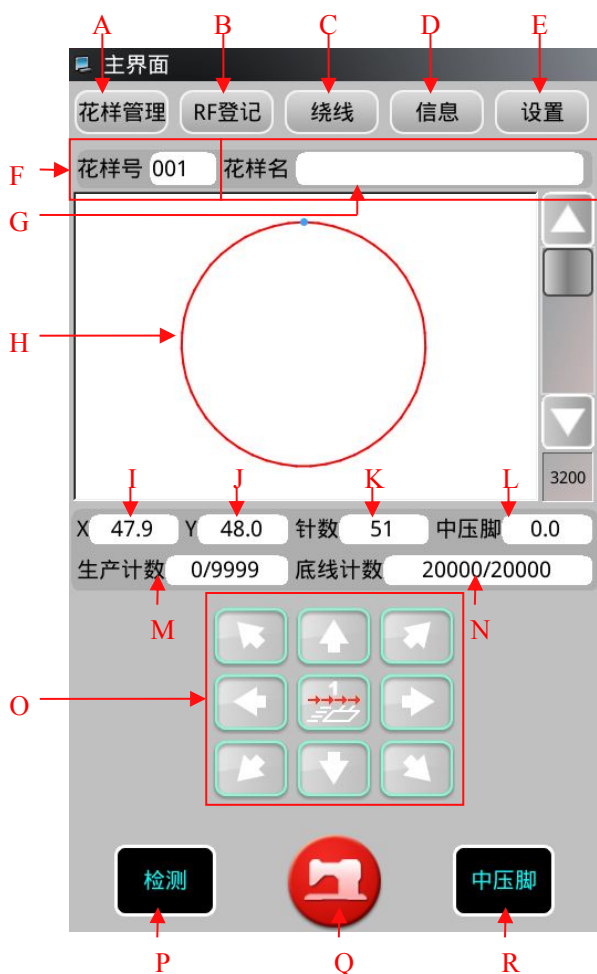

序号	功能	内容
A	花样管理	可选择、设置花样参数等
B	RF 登记	可将当前花样写入到 RF 卡中
C	绕线	可进入绕线模式
D	信息	可查看操作头统计类信息
E	设置	可设置用户参数
F	花样号	显示当前花样号
G	花样名	显示当前花样名称
H	花样预览区	单击花样预览区，可查看花样基本信息和预览花样
I	X 方向范围	显示当前花样 X 方向范围
J	Y 方向范围	显示当前花样 Y 方向范围
K	针数值	显示当前花样落针点总数
L	中压脚值	显示当前花样中压脚高度值
M	生产计数值	显示生产计数器的当前值/设置值
N	底线计数值	显示底线计数值

O	移框	可移动压框
P	检测	可进入检测模式，检测输入输出和其他信号
Q	切换	花样缝制界面和花样选择界面互相切换
R	中压脚	提升或者下降中压脚

2.1 花样预览

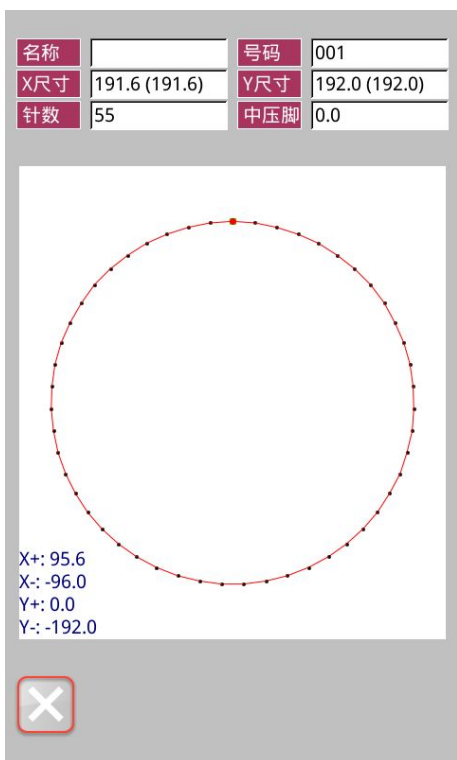

在【花样选择】或【花样缝制】界面，单击花样预览区，可进入【花样预览】界面，显示如下信息：

- ① 花样名称
- ② 花样号
- ③ X 尺寸
- ④ Y 尺寸
- ⑤ 针数
- ⑥ 中压脚高度
- ⑦ 花样坐标

2.2 检测功能



在【花样选择】界面，单击“检测”，进入【检测】

界面，通过上下翻页键翻页。

- 1) 输入信号检测
- 2) 输出信号检测
- 3) 主轴电机校正
- 4) 转速检测
- 5) XY 电机原点检测
- 6) 中压脚电机检测
- 7) 剪线电机检测
- 8) 连续运转

- 9) 抓线电机检测
- 10) RFID 设置
- 11) 扩展功能检测
- 12) 多功能 IO 检测
- 13) 触摸屏校正
- 14) 液晶检测

2.2.1 输入信号检测



在【检测】界面，单击“输入信号检测”，进入【输入信号检测】界面，可通过按下开关或者隔挡传感器，观察各种开关和传感器的输入信号变化。

ON：表示开启

OFF：表示关闭

0：表示条码扫描输入的号码，默认为 0

可显示当前输入信号状态：

- (01) 启动按钮
- (02) 压框按钮
- (03) 急停按钮
- (04) 断线检测
- (05) X 原点传感器
- (06) Y 原点传感器
- (07) 抓线原点传感器
- (08) 抓线位置传感器
- (09) 中压脚原点传感器
- (10) 安全开关
- (11) 三联踏板检测
- (12) 输入 1
- (13) 输入 2
- (14) 输入 3
- (15) 输入 4
- (16) 输入 5
- (17) 输入 6
- (18) 输入 7
- (19) 输入 8
- (20) 条码扫描检测
- (21) 自启动信号 1
- (22) 自启动信号 2



2.2.2 输出信号检测



在【检测】界面，单击“输出信号检测”，进入【输出信号检测】界面，在该界面下可以检测电磁铁和气阀的输出状态：

- (01) 拨线
- (02) 气剪线
- (03) 电剪线
- (04) 压框
- (05) 中压脚
- (06) 松线
- (07) 辅助压脚
- (08) 气阀输出 1

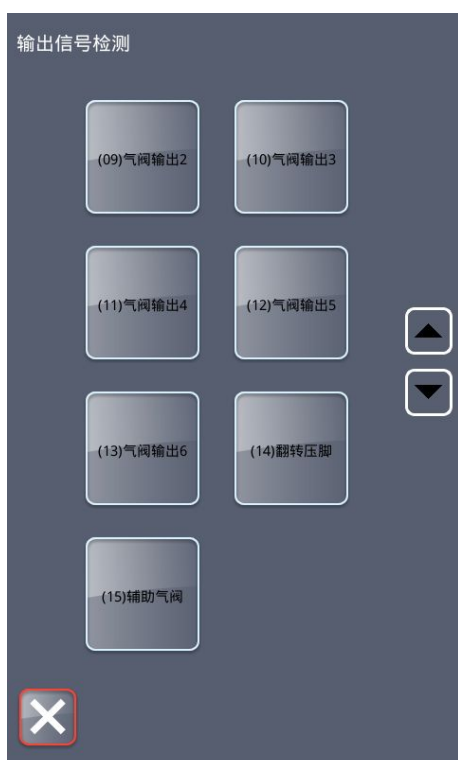

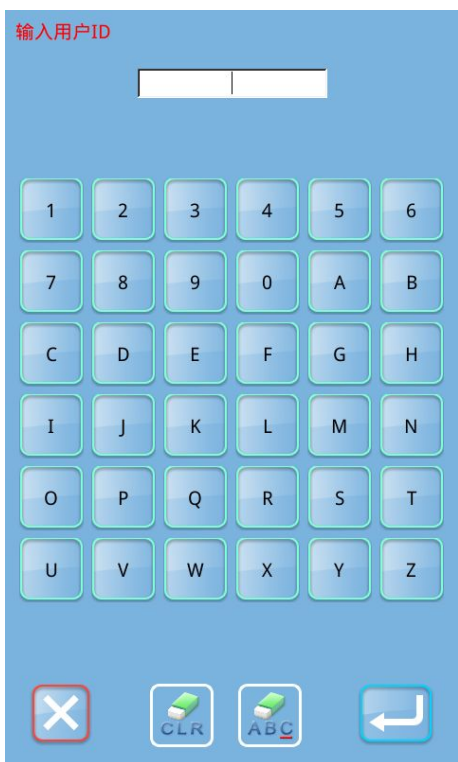

- (09) 气阀输出 2
- (10) 气阀输出 3
- (11) 气阀输出 4
- (12) 气阀输出 5
- (13) 气阀输出 6
- (14) 翻转压脚
- (15) 辅助气阀

2.2.3 主轴电机校正

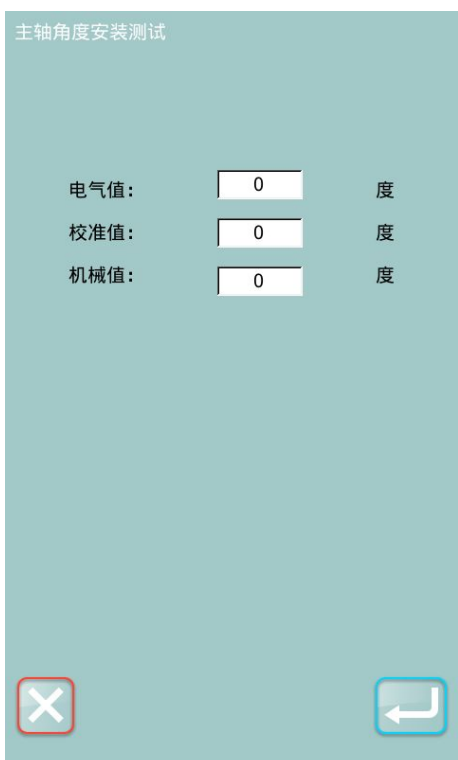

在【检测】界面，单击“主轴电机校正”，系统将提示输入密码，密码输入无误，则可进入【主轴角度安装测试】界面。



在【主轴角度安装测试】界面，在当前界面下拆下主轴马达，旋转手轮将缝纫机针杆摇到最高点，重新装好主轴马达，确认显示的电气值在 0-30 度或 330-360 度范围内，然后按下确定键；否则拆下主轴重复以上操作。

2.2.4 转速测试



在【检测】界面，单击“转速测试”，进入【转速测试】界面。

② 可以显示当前主轴电机“目标转速”和“实际转速”。

② 可以通过单击“转速减”和“转速加”设置

主轴电机转速，单击“开始”后，主轴电机将以已设定的转速运转。此时，实际测得的转速会显示在“实际转速”数值栏。

单击“停止”，则机器停止运转。

单击“退出”，则返回到上一级界面。

2.2.5 XY 电机原点检测



在【检测】界面，单击“XY 电机原点检测”，进入【XY 原点检测】界面，显示传感器状态和坐标信息：





- ① X 原点：根据 X 原点传感器状态，显示当前 X 原点传感器 ON/OFF 状态。
- ② Y 原点：根据 Y 原点传感器状态，显示当前 Y 原点传感器 ON/OFF 状态。
- ③ X 绝对坐标：显示 X 绝对坐标值，数值会根据电机移动而变化
- ④ X 相对坐标：显示 X 相对坐标值，数值会根据电机移动而变化
- ⑤ Y 绝对坐标：显示 Y 绝对坐标值，数值会根据电机移动而变化
- ⑥ Y 相对坐标：显示 Y 相对坐标值，数值会根据电机移动而变化
- ⑦ 驱动电机方向键：可驱动电机移动，上方将跟随显示 X/Y 绝对值和 X/Y 相对值
- ⑧ 回到原点



在【XY 原点检测】界面下，可选择【检测】和【偏移】界面。系统默认进入界面为【检测】界面，该界面下“检测”图标显示



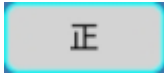

为蓝色，显示内容如下：

- ⑨ X 原点传感器安装位置：单击右侧“右侧”或“左侧”，可切换 X 原点传感器安装位置。
- ⑩ X 正方向：单击右侧“反”或“正”，可切换 X 正方向的方向。
- ⑪ Y 正方向：单击右侧“正”或“反”，可切换 Y 正方向的方向。



⑫ X步距角微调：显示当前 X 步距角微调值，可通过单击右侧数值 ，进入【U40 X 步距角微调】参数设置界面：

通过界面下方数字键输入数值，单击“确认”  确认数值，

并返回【XY 原点检测】界面，单击“返回”  取消操作，并返回【XY 原点检测】界面。

在【XY 原点检测】界面，单击 X 步距角微调右侧“还原” ，可还原数值。

⑬ Y 步距角微调：显示当前 Y 步距角微调值，可通过单击右侧数值 ，进入【U41 Y 步距角微调】参数设置界面，参数设置方法同【⑫ X 步距角微调】。



【XY 原点检测】界面，单击“偏移” ，进入【偏移】

界面，该界面下“偏移”图标显示蓝色 ，界面显示 X 轴原点偏移值和 Y 轴原点偏移值。

通过单击该界面中方向键，可驱动电机移动，上方将随动显示 X/Y

绝对值和 X/Y 相对值，移动完成后，单击“确认” ，X/Y 轴原点偏移值将会在 X 轴原点偏移的右侧数值处和 Y 轴原点偏移的右侧数值处显示。



① X 轴原点偏移：显示当前 X 轴原点偏移值，可通过单击右侧数值 **646**，进入【K189 X 轴原点偏移】参数设置界面：

通过界面下方数字键输入数值，单击“确认”  确认数值，

并返回【XY 原点检测】界面，单击“返回”  取消操作，并返回【XY 原点检测】界面。

在【XY 原点检测】界面，单击 X 轴原点偏移右侧“还原” ，可还原数值。

② Y 轴原点偏移：显示当前 Y 轴原点偏移值，可通过单击右侧数值 **-2.0**，进入【K01 Y 轴原点偏移】参数设置界面，参数设置方法同【① X 轴原点偏移】。

2.2.6 中压脚原点检测



在【检测】界面，单击“中压脚原点检测” ，进入【中压脚原点检测】界面。

在【中压脚原点检测】界面下，可选择【检测】和【位置】界面。系统默认进入界面为【检测】界面，该界面下“检测”图标显示

为蓝色 ，显示内容如下：

① 中压脚原点状态：根据中压脚原点状态，显示当前中压脚原点传感器 ON/OFF 状态

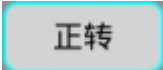
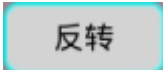
② 中压脚电机转向：单击右侧“正转”  或“反转” ，可切换中压脚电机转向。

③ 单击“上移” ，中压脚上移

④ 单击“下移” ，中压脚下移



⑤ 单击“原点”, 回到原点

在【中压脚原点检测】界面下，单击“位置”, 进入【位



置】界面，进入后图标显示为蓝色, 界面显示内容如下：

① 中压脚原点状态：根据中压脚原点状态，显示当前中压脚原点传感器 ON/OFF 状态

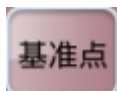
② 单击“原点”, 回到原点

③ 单击“基准点”, 下降到基准点

④ 中压脚随动高度：显示当前中压脚随动高度，单击“上移”

, 可加大中压脚随动高度值，单击“下移”,

可减小中压脚随动高度值，设置完成后，单击“确定”,

确定中压脚随动高度，单击“还原”, 还原默认中压脚随动高度值。

2.2.7 剪线电机检测





在【检测】界面，单击“剪线电机检测”，进入【剪线电机检测】界面。

在【剪线电机检测】界面下，可选择【检测】和【位置】界面。系统默认进入界面为【检测】界面，该界面下“检测”图标显示

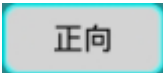

为蓝色，显示内容如下：

① 剪线原点状态：根据剪线原点状态，显示当前剪线原点传感器 ON/OFF 状态

② 剪线电机正方向：单击右侧“正向”或“反向”，可切换剪线电机正方向的方向。

③ 单击“反转”，电机进行反转，单击“正转”，

电机进行正转，单击“原点”，电机回到原点。

在【剪线电机检测】界面下，单击“位置”，进入【位置】界面，





此时“位置”图标显示为蓝色，显示内容如下：

① 剪线原点状态：根据剪线原点状态，显示当前剪线原点传感器 ON/OFF 状态

② ：单击“测剪线”后，电机执行一次剪线动作

③ ：单击“剪线位置”后，剪线电机旋转到剪线位置（回刀位置）

④ ：单击“分线位置”后，剪线电机旋转到分线位置（出刀位置）

⑤ ：单击“原点”后，剪线电机回到初始位置（上述进行剪线位置分线位置操作后，按此功能键回到初始位置）







② 剪线电机行程：显示当前剪线电机行程值，可通过单击右侧数值 ，进入【U19 剪线电机行程】参数设置界面：

通过界面下方数字键输入数值，单击“确认”  确认数值，

并返回【剪线电机检测】界面，单击“退回”  取消操作，并返回【剪线电机检测】界面。

在【剪线电机检测】界面，单击剪线电机行程右侧“还原” ，可还原数值。

③ 分线行程：显示当前分线行程值，可通过单击右侧数值 ，进入【U20 分线行程】参数设置界面，参数设置方法同【② 剪线电机行程】。

④ 分线时间：显示当前分线时间值，可通过单击右侧数值 ，进入【U21 分线时间】参数设置界面，参数设置方法同【② 剪线电机行程】。

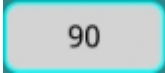
⑤ 剪线时间：显示当前剪线时间值，可通过单击右侧数值 ，进入【U22 剪线时间】参数设置界面，参数设置方法同【② 剪线电机行程】。

⑥ 分线角度：显示当前分线角度值，可通过单击右侧数值 ，进入【U23 分线角度】参数设置界面，参数设置方法同【② 剪线电机行程】。

2.2.8 连续运转



在【检测】界面，单击“连续运转”，进入【连续运转测试】界面，界面显示内容如下：

① 动作间隔：显示当前动作间隔值，单位：×100ms，间隔值的范围（0~99），可使用界面下方数字键输入数值，单击“确认”

 确认数值，并返回【检测】界面，单击“退回”

取消操作，并返回【检测】界面。

② 收针原点检测：显示当前收针原点检测值，范围（0~2），可

使用界面下方数字键输入数值，单击“确认” 确认数值，

并返回【检测】界面，单击“退回” 取消操作，并返回【检测】界面。

2.2.9 抓线电机检测

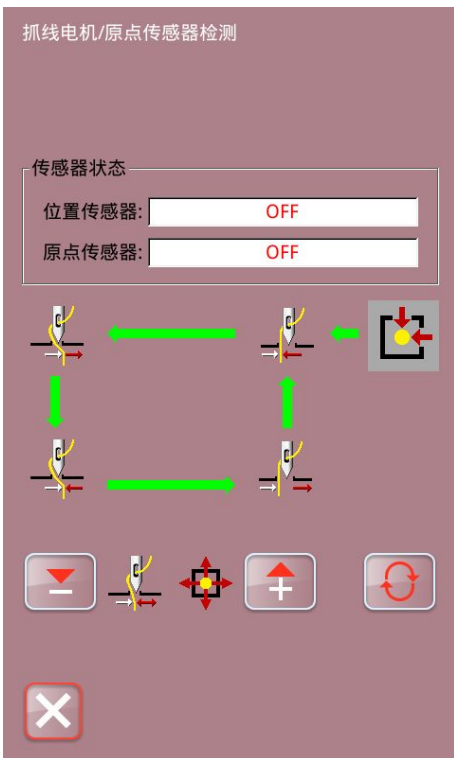

在【检测】界面，单击“抓线电机检测”，进入【抓线电机/原点传感器检测】界面，界面显示内容如下：

① 传感器状态：
位置传感器：根据抓线机构位置状态，显示抓线位置传感器的ON/OFF 状态。
原点传感器：根据抓线原点传感器的状态，显示抓线原点传感器的ON/OFF 状态。

原点传感器：根据抓线原点传感器的状态，显示抓线原点传感器的ON/OFF 状态。

② 单击 或，抓线电机将单步进行移动。单击

，可切换抓线电机不同位置，显示该位置的图形为阴影。

：待机位置（身前）

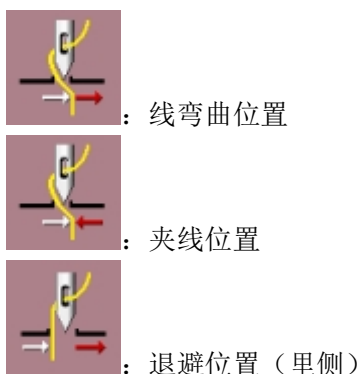

检测完成后，单击“退出”，退出【抓线电机/原点传感器检测】界面。

通过启动 SW 进行抓线电机的原点检索。

注：用启动开关进行抓线电机原点检索之后，变为有效



2.2.10 RFID 设置

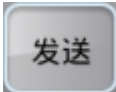

在【检测】界面，单击“RFID 设置”，进入【RFID 设置】界面，界面显示当前花样号，范围（1~999），可使用界面下方

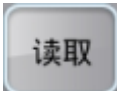
数字键输入花样号码，单击“发送”，将当前输入的花

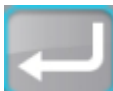
样编号写入到 RF 卡中，单击“读取”，可读取 RF 卡

中花样编号；单击“确定”或“返回”，可返回到【检测】界面。

2.2.11 扩展功能检测



在【检测】界面，单击“扩展功能检测”，进入【自动换梭/切刀检测】界面，可检测各扩展功能输入/输出信号：

- ① 激光电源
- ② 激光压料气阀
- ③ 激光切割信号
- ④ 激光废气气阀
- ⑤ 激光安全开关
- ⑥ 激光指示灯



- ⑦ 换梭电机
- ⑧ 抓紧气缸
- ⑨ 夹紧气缸
- ⑩ 抓臂气缸
- ⑪ 换芯信号
- ⑫ 换梭单步测试
- ⑬ 换梭动作复位





- ⑭ 旋转切刀电机
- ⑮ 旋转切刀复位
- ⑯ 提升气缸
- ⑰ 压料气缸
- ⑱ 切刀启动
- ⑲ 切刀提升汽缸原点信号

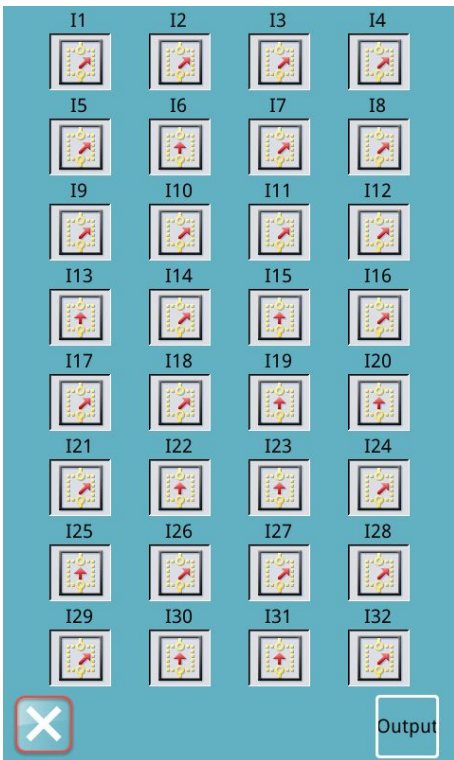

- ⑳ 直线切刀
- ㉑ 直线切刀动作模拟
- ㉒ 直线切刀原点传感器状态

2. 2. 12 多功能 IO 检测



在【检测】界面，单击“多功能 IO 检测”，进入【多功能 IO 检测】界面。

在【多功能 IO 检测】界面下，可选择【Output】和【Input】界面。系统默认进入界面为【Output】界面，该界面下可检测输入信号

状态，单击“Output”，可进入【Input】界面。

单击“Input”，可切换至【Output】界面。

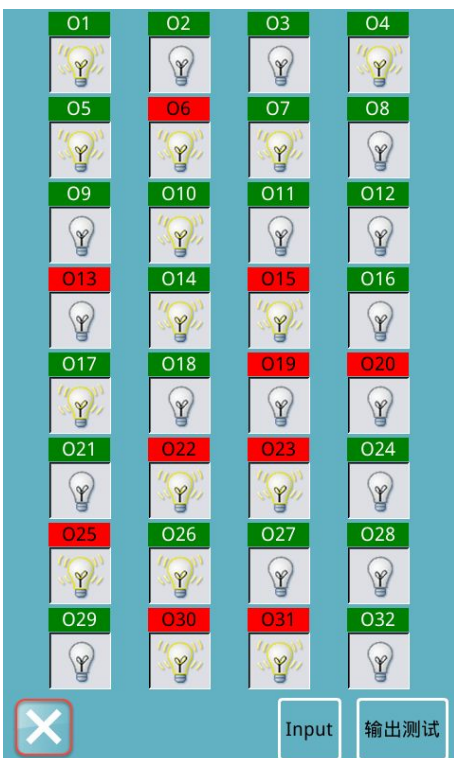

在【Input】界面，可检测输出信号状态。

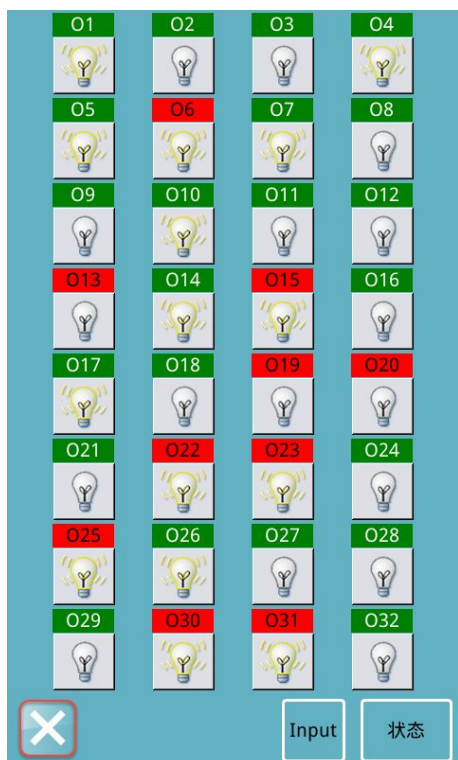

输出测试

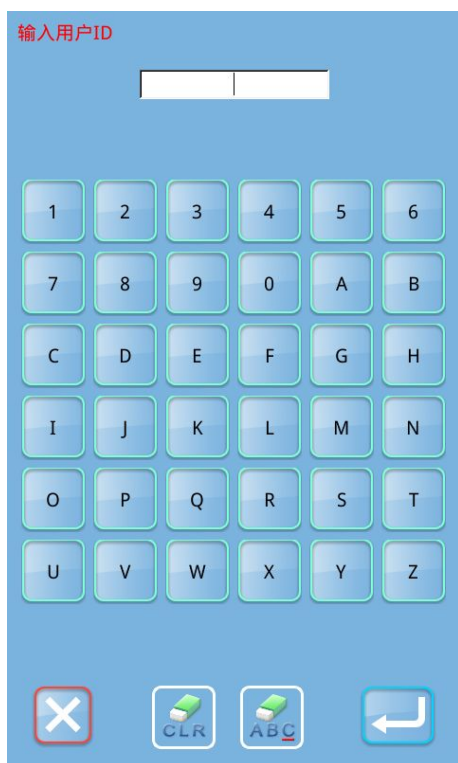

单击“输出测试”，可测试输入信号。

2.2.13 触摸屏校正





在【检测】界面，单击“触摸屏校正”，系统将提示输入密码，密码输入无误，系统将提示[M-031]确定进入触摸屏校正模式？

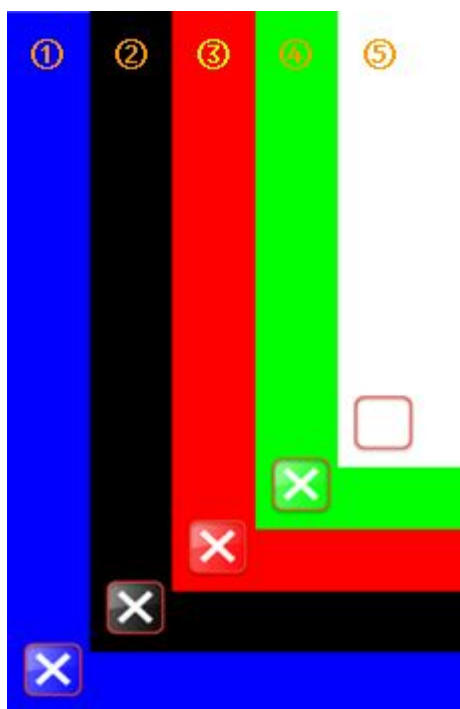

提示【[M-031]确定进入触摸屏校正模式?】界面，单击“是”，则可进入【触摸屏校正】界面，单击“否”，则退出触摸屏校正。

2.2.14 液晶检测









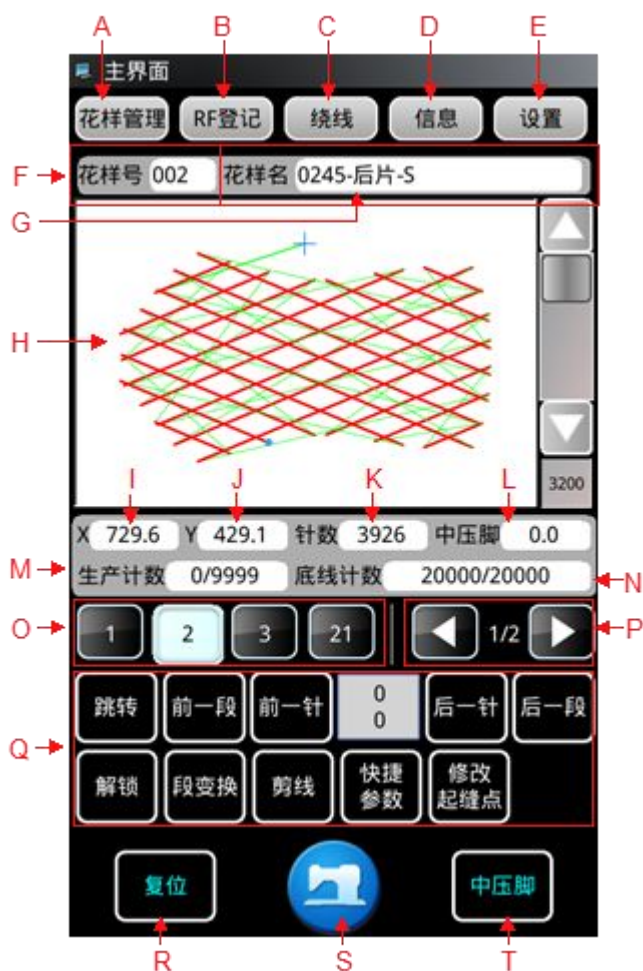

在【检测】界面，单击“液晶检测”，可进入【液晶检测】界面，进入后屏幕显示为蓝色，单击屏幕，颜色将以：蓝色→黑色→红色→绿色→白色→蓝色……循环切换颜色，单击“退出”，返回到【检测】界面。

3 花样缝制界面

在【花样选择】界面，单击 ，进入缝制界面，可设置花样缝制参数。





序号	功能	描述
A	花样管理	进入【花样管理】界面
B	RF 登记	可将当前花样写入到 RF 卡中
C	绕线	可进入绕线模式
D	信息	可查看操作头统计类信息
E	设置	可设置用户参数
F	花样号	显示当前花样号
G	花样名	显示当前花样名称
H	花样预览区	单击花样预览区，可查看花样基本信息和预览花样
I	X 方向范围	显示当前花样 X 方向范围
J	Y 方向范围	显示当前花样 Y 方向范围
K	针数	显示当前花样落针点数值
L	中压脚高度	显示当前花样中压脚高度值

M	生产计数	显示生产计数器的当前值/设置值
N	底线计数	显示底线计数值
O	快捷花样列表	显示所有已存花样列表
P	翻页	可翻页快捷花样列表
Q	各项功能参数编辑键	<p>: 按下后可进入跳转界面，输入跳转针数/段数，按下“确认”</p> <p>键，模板可移动到所输入针数/段数位置。</p> <p>: 锁定当前编辑花样，防止当前花样被切换，只可自动切换花样，不可手动切换花样</p> <p>: 可手动切换花样，不可自动切换花样。</p> <p>: 可对花样中某段进行修改</p> <p>: 执行一次剪线动作</p> <p>: 可进入【快捷参数】设置界面</p> <p>: 移动起缝点位置</p>
R	复位	回原点
S	切换到花样选择界面	切换到花样选择界面
T	中压脚	中压脚功能设置

3.1 中压脚功能



在【花样缝制】界面，单击“中压脚”，进入【中压脚设置】界面，可设置如下参数：

① 中压脚基准值：可设置中压脚基准值，单击“中压脚基准值”，选中后左侧显示，参数选中状态下，会显示当前参数范围，该范围会根据所选参数自动更新，参数值可通过下方数字键

修改，修改完成后，单击“确定”，确认修改并返

回【花样缝制】界面，单击“取消”，取消操作并返回【花样缝制】界面。

② 中压脚随动高度：可设置中压脚随动高度值，操作方法同“① 中压脚基准值”

③ 中压脚压布角度设置：可设置中压脚压布角度值，操作方法同“① 中压脚基准值”

④ 辅助压脚抬起延时：可设置辅助压脚抬起延时值，操作方法同“① 中压脚基准值”

⑤ 辅助压脚落下延时：可设置辅助压脚落下延时值，操作方法同“① 中压脚基准值”

⑥ 中压脚抬起延时：可设置中压脚抬起延时值，操作方法同“① 中压脚基准值”

⑦ ：断线后回退

注：此功能仅在参数 U14-21 断线后回退开关，参数值设置为 1 或 2 时有效；回退针数可在参数 U14-22 断线后回退针数设置。

⑧ 锁定：锁定当前编辑状态，锁定后参数修改无效，修改参数时必须将状态切换为解锁。

：可修改中压脚参数。

：修改中压脚参数无效

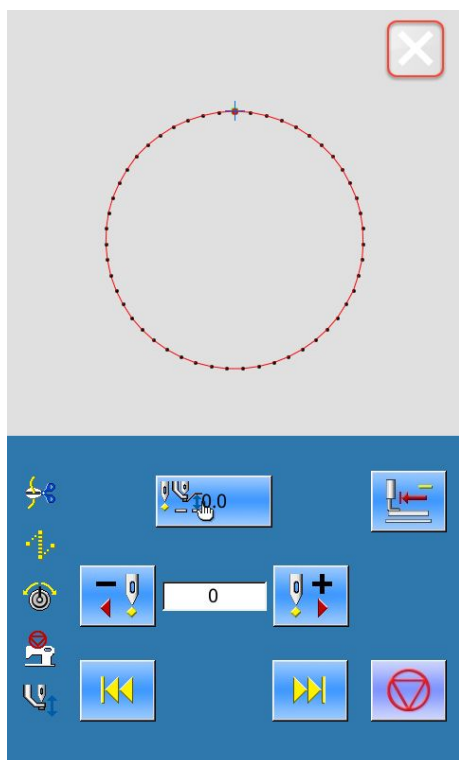

⑨ : 设置单针中压脚高度

单击“设置单针中压脚高度”, 进入【设置单针中压脚

高度】界面, 单击“”“”可选择需设置中压脚高度的位置。

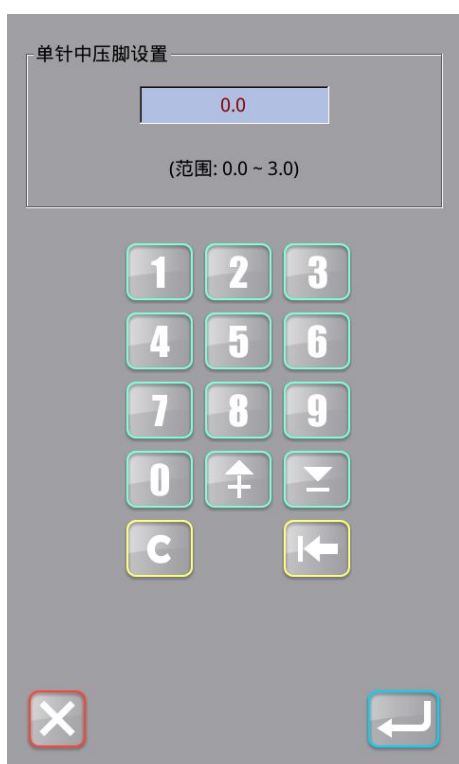

单击“单针中压脚设置”键, 进入【单针中压脚设置】界面, 可更改中压脚高度, 单击“保存”键, 保存成功后单击“关闭”, 返回【中压脚设置】界面。

3.2 修改起缝点

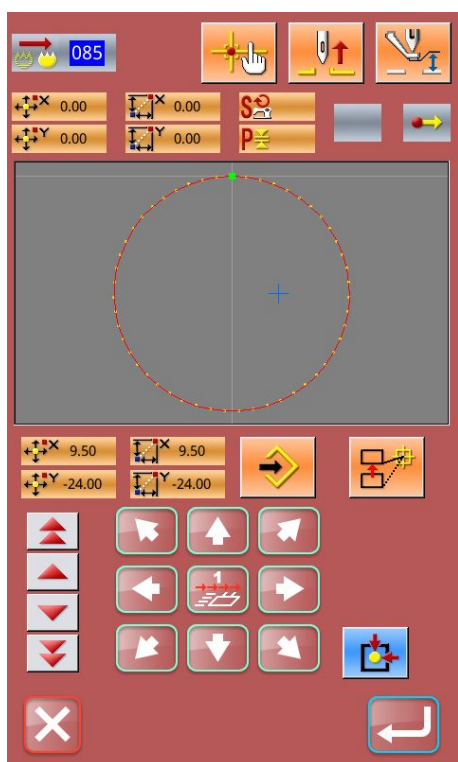

导入的花样如果位置与模板有差异，用户可以根据需要修改起缝点。



在【花样缝制】界面，单击“修改起缝点”键，进入【修改起缝点】界面，如图所示。



按下移动键，可以将起缝点移动到指定位置。

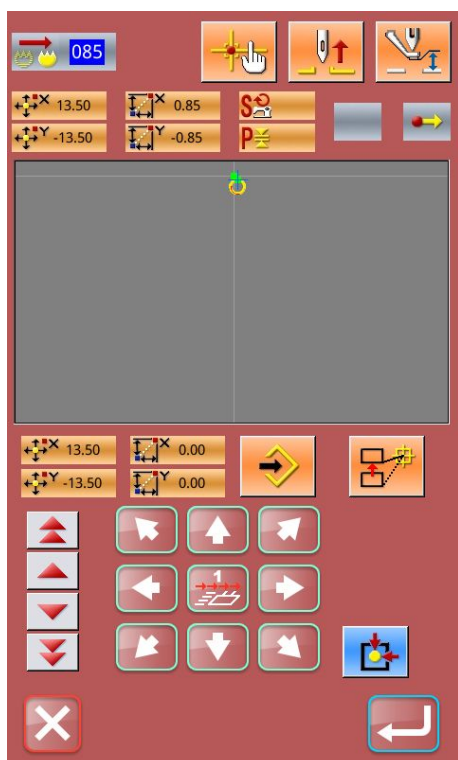

按“保存”键，完成操作，起缝点移动到指定位置。

可通过“”试缝按键确认上一次修改后的起缝点位置是否准确：

上一段，单击后，跳转到当前位置的上一段；

上一针，单击后，跳转到当前位置的上一针；

下一针，单击后，跳转到当前位置的下一针；

下一段，单击后，跳转到当前位置的下一段。

试缝到花样中任意一点都可以继续以此针为基准移动花样位置，



设置完成后，单击“保存”键，完成操作，起缝点移动

到指定位置；单击“退出”键，返回花样缝制界面。



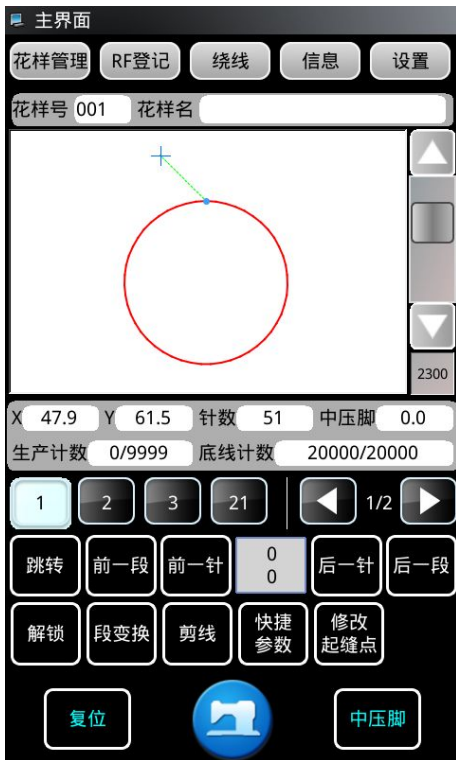

单击“退出”



后，返回花样缝制界面。

4 花样管理

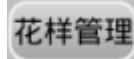
在【花样缝制】或【花样选择】界面，单击“花样管理”，可进入【读取花样】界面，

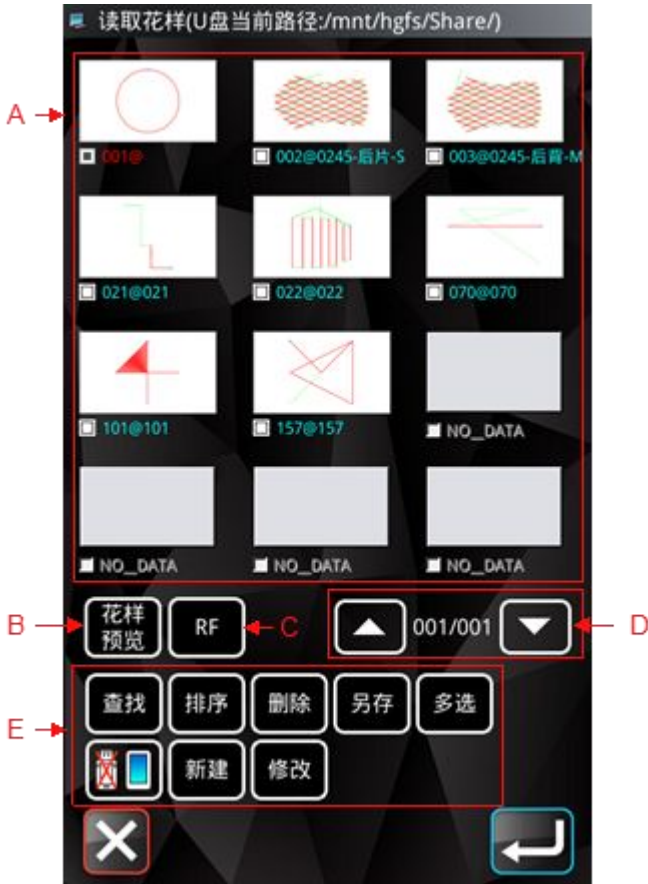





序号	功能	功能描述
A	花样列表	已存花样会显示花样、号码、名称，单击花样或者花样名称即可选中花样
B	花样预览	单击后可预览花样，详见【 2.1 花样预览 】
C	RF	单击后可将选中花样输出到 RFID 记忆卡中
D	翻页键	可上下翻页花样列表
E	功能键	<div style="margin-bottom: 10px;"> : 查找花样 </div> <div style="margin-bottom: 10px;"> : 按照修改时间或号码大小进行排序重新显示花样列表 </div> <div style="margin-bottom: 10px;"> : 删除花样 </div> <div style="margin-bottom: 10px;"> : 将花样另存为 </div>

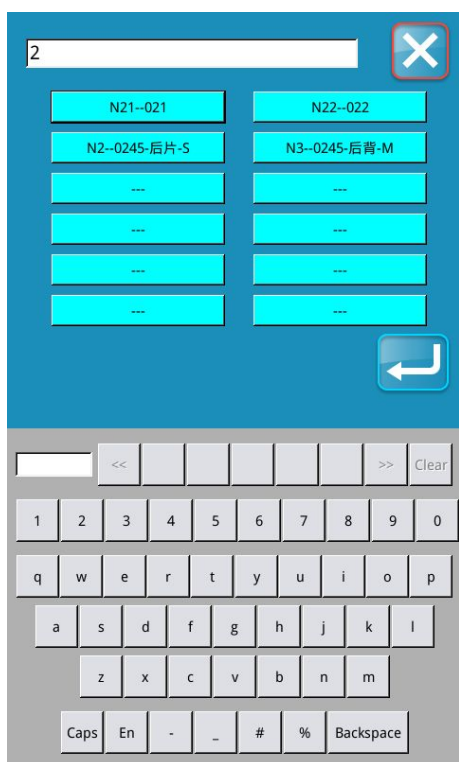

		<p>: 可选择多个花样</p> <p>: U 盘导入花样</p> <p>: 可编辑新花样，进入花样编辑界面</p> <p>: 可修改花样</p>
--	--	---

4.1 功能键



在【读取花样】界面，单击“查找”，进入【花样查找】界面，可通过下方键盘输入花样号或花样名称中字符查找花样，单击“中英文切换”或，来切换输入英文或中文，选中花样后，单击“确定”，切换花样成功并返回到【读取花样】界面，单击“取消”，不切换花样并返回到【读取花样】界面。



在【读取花样】界面，选中花样后，单击“删除”，系统将提示[M-044]是否删除选中的文件，单击“确定”，删除花样并返回到【读取花样】界面，单击“取消”，不删除花样并返回到【读取花样】界面。
注：当前正在使用的花样，是不可删除的。

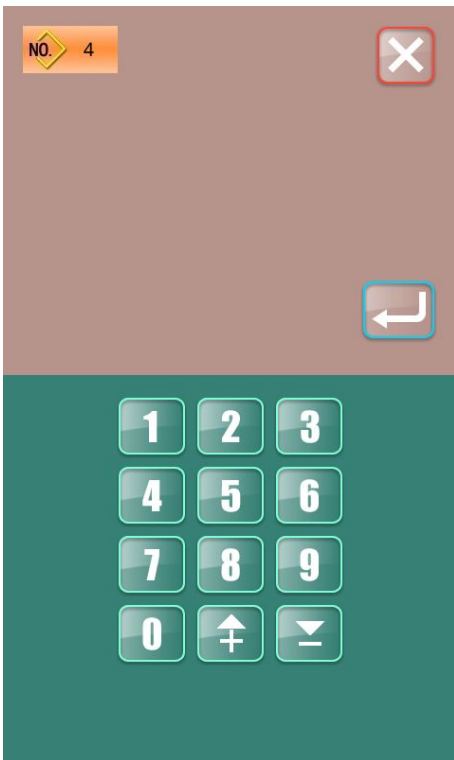

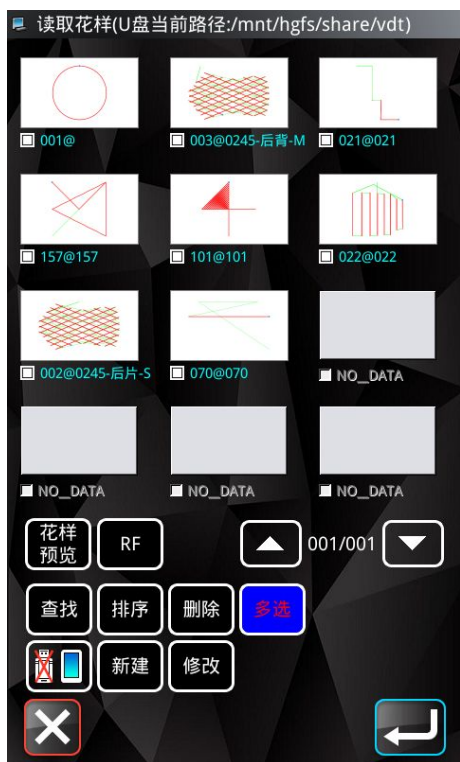

在【读取花样】界面，选中花样后，单击“另存”，则进入【花样另存】界面，可通过下方数字键输入另存为花样的名称，单击“确定”，花样另存成功并返回到【读取花样】界面，单击“取消”，取消花样另存并返回到【读取花样】界面。
 若输入的花样号已被占用，当前界面会显示该花样，单击“确定”后，系统将提示[M-039]是否覆盖花样，单击“确定”，花样另存成功并返回到【读取花样】界面，单击“取消”，取消花样另存并返回到【读取花样】界面。



在【读取花样】界面，选中花样后，单击“多选”，【读取花样】界面中花样则可进行多选，对花样进行批量操作。



在【读取花样】界面，选中花样后，单击“新建”，系统将提示[M-065]是否编辑新花样？单击“确定”，则进入【花样编辑】界面，可编辑新花样，单击“取消”，则进入【花样编辑】界面，可编辑当前花样。

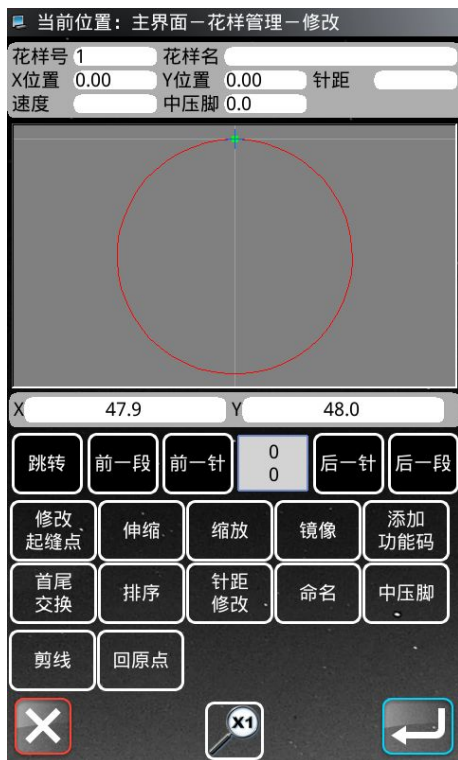

在【读取花样】界面，选中花样后，单击“修改”，可进入【花样修改】界面，修改花样。

5 设置

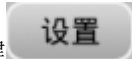
在【花样选择】界面或【花样缝制】界面，按下“设置”键 ，进入【设置】界面。



5.1 版本查询

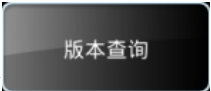

在【设置】界面，单击“版本查询”键，可以查询系统软件版本。

：将当前版本信息保存至 U 盘根目录下。

5.2 传输与升级

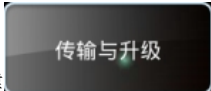

在【设置】界面，单击“传输与升级”键，可进入【通信界面】。

该界面下可选择的功能，分为四类：

- 花样传输
- 参数传输
- 软件升级
- 换机

点按相应的图标，进行功能操作。

单击“取消”键，返回【设置】界面。

5.3 伺服参数

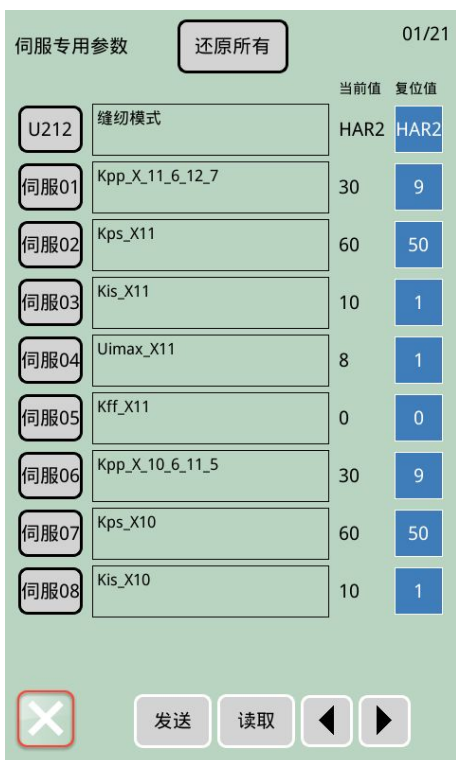

在【设置】界面，单击“伺服参数”键，可进入【伺服专用参数】界面。

伺服参数是直接关系机器缝纫性能的参数，正常出厂机器会存储默认的伺服参数，仅在缝制要求出现变化时可以修改伺服参数，修改前，需在 U212 缝纫模式参数中选择相应缝纫模式。



举例 SOF2 丝杠软模式：

在【伺服专用参数】界面，单击“U212”参数键，进入【U212 缝纫模式】参数设置界面，选择缝纫模式：SOF2 丝杠软模式。



选中后，单击“确认”键，进入缝纫模式：SOF2 丝杠

软模式，单击“取消”键，则取消操作并返回【伺服专用参数】界面。



进入缝纫模式：SOF2 丝杠软模式后，单击“还原所有”键

，系统将会提示[M-067]是否还原所有设定，单击

“确认”键，确认还原所有设定，单击“取消”键，取消操作并返回【伺服专用参数】界面。

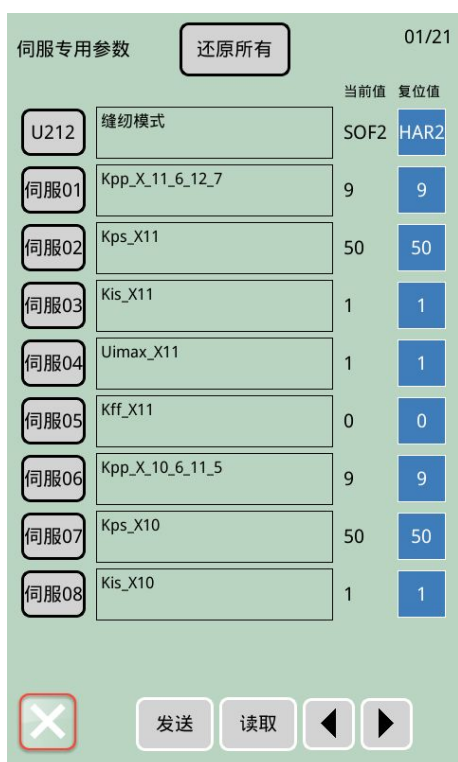

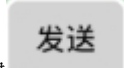
确认还原所有设定后，单击“发送”键，等待约 1s 后，

再单击“读取”键，确认伺服参数是否已发生变化。

5.4 维护与保养设置

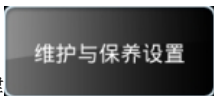
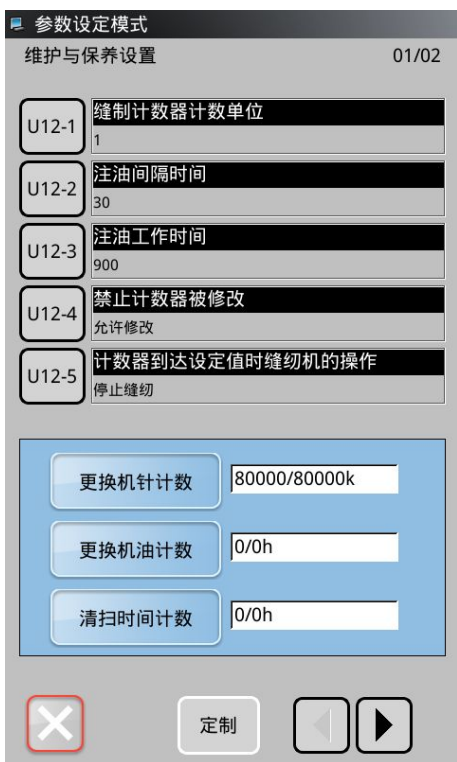

在【设置】界面，单击“维护与保养设置”键，可进入【维护与保养设置】界面，可设置 U12 参数，也可设置：
 1)更换机针计数
 2)更换机油计数
 3)清扫时间计数

5.5 参数备份与还原

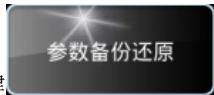

在【设置】界面，单击“参数备份与还原”键，系统将提示输入密码，密码输入成功后，将跳转至【参数备份与还原】界面。

单击选中需设置的参数后，可通过界面下方按钮操作：

清除：单击后，可删除参数

保存：单击后，可保存参数

恢复：单击后，可恢复参数

清除全部：单击后，可清除全部参数

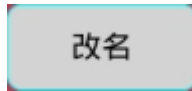

: 单击后，可更改已有参数名称

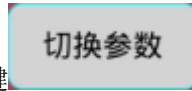

单击“切换参数”键，可切换【参数备份与还原】和【伺服参数备份还原】界面



5.6 面板设置



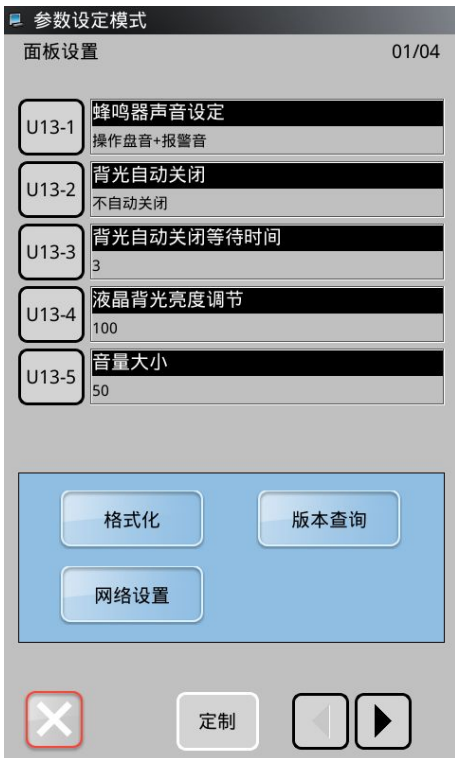

在【设置】界面，单击“面板设置”键，可进入【面板设置】界面，可设置 U13 参数，也可设置：

- 1) 格式化
- 2) 版本查询
- 3) 网络设置







在【面板设置】界面，单击“格式化”键 ，可进入【格式化操作】界面：

单击“USB”键 ，可格式化 U 盘；

单击“内存”键 ，可删除全部内存花样；

单击“P 和 C”键 ，可删除全部 P 花样和 C 花样。



在【面板设置】界面，单击“版本查询”键 ，可进入【版本查询】界面。

单击“保存”键 ，将当前版本信息保存至 U 盘根目录下。

5.7 U 参数更改方法

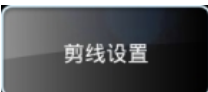

举例选择型参数设定进行参考，如下：

按下“剪线设置”键，进入【剪线设置】

界面，通过“下一页”键找到参数代码 A: U2-13，进行设置参数，此时 C:【剪线电机正方向】状态为 B:【正向】。

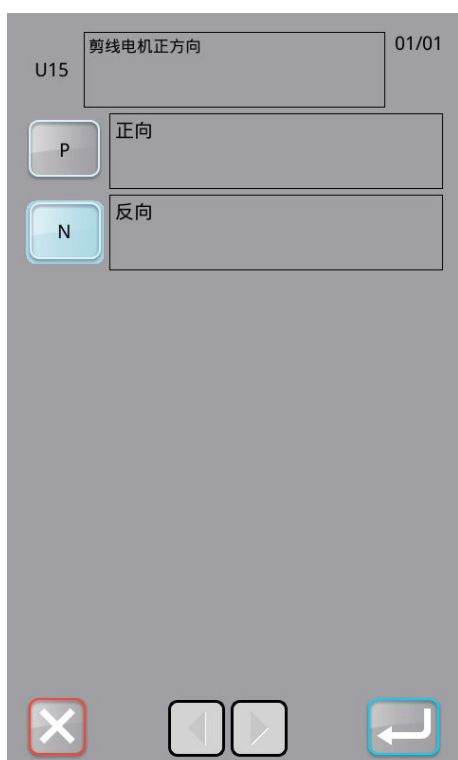

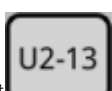
按下“U2-13 参数”键，进入【剪线电机正方向】参数设置界面，选择想要更改的模式键‘N’反向，按下“确认”

键后，即可完成对相应参数的设定更改。

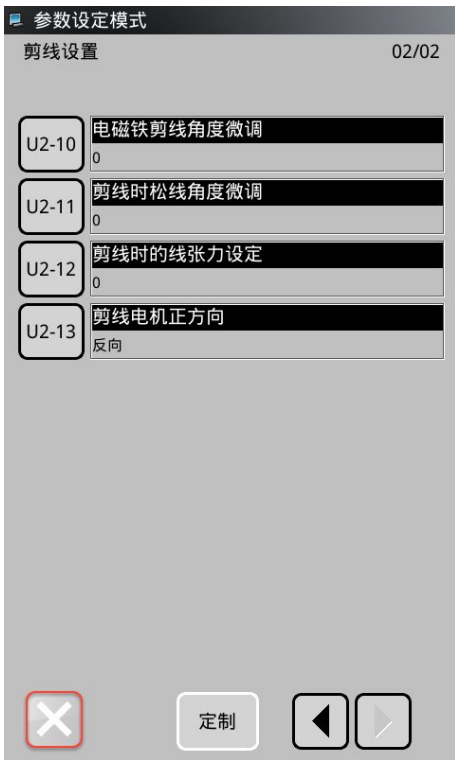

此时返回上一级界面后，【剪线电机正方向】的状态已更改为【反向】，完成参数的设置。



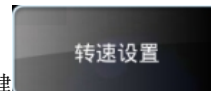

举例输入型参数设定进行参考，如下：



按下“转速设置”键，进入到【转速设置】参数设置界面，找到参数代码【U1-1】，进行设置参数，此时【最高缝制速度】参数值为【2500】。



按下“U1-1 参数”键 ，进入【最高缝制速度】参数设置界面，通过小键盘 C 在数值 A 里输入希望的值，按下确认

键  后，即可完成对相应参数的设定更改。

注：B 为参数值的输入范围。



此时返回上一级界面后，【最高缝制速度】的参数值已更改为【3000】，完成参数的设置。

5.8 已修改参数

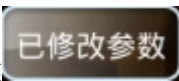

查询已修改参数

如果有参数修改，在【设置】界面右下角会显示“已修改参数”键。

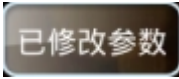
在【设置】界面，按下“已修改参数键”，可进入【已修改参数查询】界面，查询已修改过的参数。

在【已修改参数查询】界面下，可以查询所有修改过的参数列表。

还原已修改参数

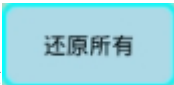
按“还原所有”键，将修改参数全部恢复为出厂值。

点按参数名称键，例如 U8-7 “X 轴原点偏移”

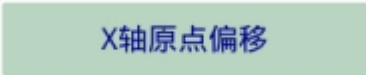
，再按“选择还原”键

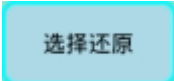
将选中的参数恢复为出厂值，也支持复选操作。

按参数号码键，例如 U14-5 键，能够进入参数设置界面，可以重新设置参数数值。

按“返回”键，退出该界面。

5.9 参数定制

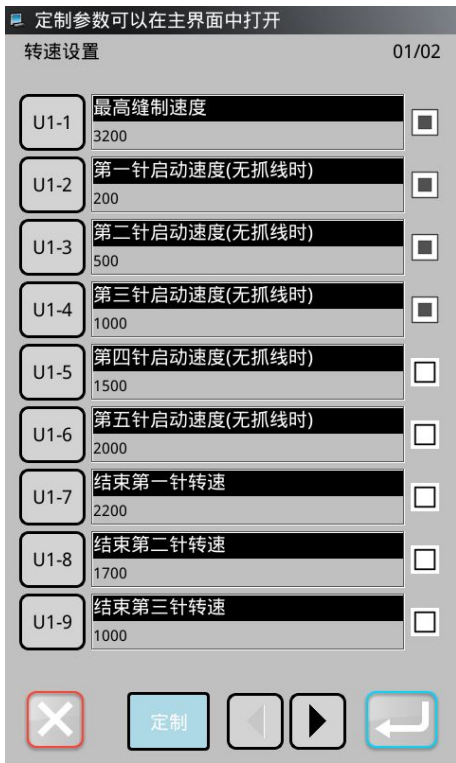

举例“转速设置”参数定制：

在【设置】界面，单击“转速设置”键

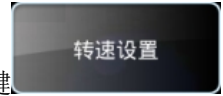

进入【转速设置】界面，单击“定制”键



系统将提示输入密码，密码输入成功后，将进入【定制转速设置参数】界面，可进行参数定制。
通过单击参数后方方框，表示未被定制为快捷参数，表示被定制为快捷参数。

设置后单击“确认”键



退出定制。

注：定制参数可以在主界面的快捷参数中打开。

5.10 用户参数表

U1 转速设置

代码	简述	初始值	范围	步长/单位
U1-1	最高缝制速度	3200	200-3200	100
U1-2	第一针启动速度（无抓线时）	200	200-1500	100
U1-3	第二针启动速度（无抓线时）	500	200-2700	100
U1-4	第三针启动速度（无抓线时）	1000	200-2700	100
U1-5	第四针启动速度（无抓线时）	1500	200-2700	100
U1-6	第五针启动速度（无抓线时）	2000	200-2700	100
U1-7	结束第一针转速	2200	200-2800	100
U1-8	结束第二针转速	1700	200-2800	100
U1-9	结束第三针转速	1000	200-2800	100
U1-10	结束第四针转速	600	200-2800	100
U1-11	第一针启动速度（有抓线时）	600	200-3200	100
U1-12	第二针启动速度（有抓线时）	900	200-3200	100
U1-13	第三针启动速度（有抓线时）	1200	200-3200	100
U1-14	第四针启动速度（有抓线时）	1500	200-3200	100
U1-15	第五针启动速度（有抓线时）	1800	200-3200	100

U1-16	绕线速度设置	2500	200-3200	100
-------	--------	------	----------	-----

U2 剪线设置

代码	简述	初始值	范围	步长/单位
U2-1	是否允许剪线	允许	允许, 禁止	
U2-2	剪线速度	240	200-800	10/rpm
U2-3	剪线类型	CIR: 圆刀电机剪线	MAG: 电磁铁剪线 AIR: 气动剪线 CIR: 圆刀电机剪线 EQU: 平刀电机剪线	
U2-4	剪线电机行程	88	0-250	1
U2-5	分线行程	50	0-250	1
U2-6	分线时间	17	0-200	1/ms
U2-7	剪线时间	90	0-200	1/ms
U2-8	分线角度	305	0-359	1
U2-9	暂停时剪线方式	MAN: 手动剪线	AUT: 自动剪线 MAN: 手动剪线	
U2-10	电磁铁剪线角度微调	0	-20-20	1
U2-11	剪线时松线角度微调	0	-50-50	1
U2-12	剪线时的线张力设定	0	0-200	1
U2-13	剪线电机正方向	正向	P: 正向 N: 反向	

U3 中压脚设置

代码	简述	初始值	范围	步长/单位
U3-1	中压脚类型	MO: 电机	MO: 电机 AIR: 气动	
U3-2	闭环中压脚随动模式	10	0-99	1
U3-3	中压脚起缝下压针数	1	0-5	1
U3-4	试缝时中压脚和辅助压脚状态	1: 降下	0: 抬起 1: 降下	
U3-5	断线后中压脚和辅助压脚状态	UP: 抬起	UP: 抬起 DOWN: 降下	
U3-6	起缝前几针降低基准高度: 开关	0: 关闭	0: 关闭 1: 车缝起始位置打开 2: 车缝中间位置打开 3: 车缝起始中间位置都打开	
U3-7	起缝前几针降低基准高度: 针数	1	1-15	1
U3-8	起缝前几针降低基准高度: 降低距离	0.1	0.1-2.0	0.1

U3-9	起缝前几针调整随动高度: 开关	关闭	OFF: 关闭 ON: 开启	
U3-10	起缝前几针调整随动高度: 针数	1	1-15	1
U3-11	起缝前几针调整随动高度: 新随动高度	0.1	0.1-7.0	0.1
U3-12	中压脚下降起始角度	0	0-359	1
U3-13	中压脚下降动作时间	0	0-63	1
U3-14	中压脚上升起始角度	0	0-359	1
U3-15	中压脚上升动作时间	0	0-63	1
U3-26	结束前几针降低基准高度: 开关	0: 关闭 1: 打开		
U3-27	结束前几针降低基准高度: 针数	1	1-15	1
U3-28	结束前几针降低基准高度: 降低距离	0.1	0.1-2.0	0.1

U4 拐点降速

代码	简述	初始值	范围	步长/单位
U4-1	拐点降速开关	打开	OFF: 关闭 ON: 打开	
U4-2	拐点速度	1000	200-2000	100
U4-3	拐点后第一针速度	2200	200-2800	100
U4-4	拐点后第二针速度	1900	200-2800	100
U4-5	拐点后第三针速度	1700	200-2800	100
U4-6	拐点后第四针速度	1200	200-2800	100

U5 激光切割

代码	简述	初始值	范围	步长/单位
U5-1	激光切刀使能开关	关闭	OFF: 关闭 ON: 打开	
U5-2	X 切刀偏移	0.0	-500.0-500.0	0.1
U5-3	Y 切刀偏移	0.0	-500.0-500.0	0.1
U5-4	切刀同步延时	50	0-255	1
U5-5	激光切割段中延时	1	1-30000	1
U5-6	激光切割首段延时	1	1-30000	1
U5-7	激光切割总电源的保持时间	0	0-100	1
U5-8	激光段中空送激光头是否抬起	允许	OFF: 禁止 ON: 允许	
U5-9	提升气缸原点信号检测使能	打开	OFF: 关闭 ON: 打开	
U5-10	激光切刀通信异常保护次数	1	1-10	1

U6 动框速度与时序

代码	简述	初始值	范围	步长/单位
U6-1	空送速度档位	2	0-9	1
U6-2	缝制结束回原点速度档位	2	0-9	1
U6-3	试缝速度档位	50	1-100	1
U6-4	X 轴起缝动框角度微调	0	-120-120	1
U6-5	Y 轴起缝动框角度微调	0	-120-120	1
U6-6	X 轴动框角度微调	0	-120-120	1
U6-7	Y 轴动框角度微调	0	-120-120	1
U6-8	X 轴动框时间微调	0	-100-100	1
U6-9	Y 轴动框时间微调	0	-100-100	1

U7 首尾加固与断线检测

代码	简述	初始值	范围	步长/单位
U7-1	起缝原点加固针数	0	0-2	1
U7-2	起始针加固方式设置	在前几针加固	0: 不加固 1: 在第一针加固 2: 前几针加固 3: 曲折缝加固	
U7-3	起缝加固针数	-2	-4-4	1
U7-4	结束针加固方式设置	结束时 N 型加固三针	0: 不加固 1: 结束时前 0.1mm 处加固一针 2: 结束时 N 型加固两针 3: 结束时 N 型加固三针 4: 结束时 N 型加固四针 5: 结束时 V 型加固两针	
U7-5	断线检测是否打开	打开	OFF: 关闭 ON: 打开	
U7-6	断线传感器触发方式	高电平	L: 低电平 H: 高电平	
U7-7	断线检测时缝制开始的无效针数	8	0-15	1
U7-8	断线检测时缝制中途的无效针数	5	0-15	1

U8 主轴停车与原点

代码	简述	初始值	范围	步长/单位
U8-1	机针停止位置	上位置	UP: 上位置 DEAD: 上死点	
U8-2	回原点后机针停止位置	上位置	UP: 上位置 DEAD: 上死点	
U8-3	机针上死点角度	0	0-80	1
U8-4	机针上位置角度	53	30-80	1

U8-5	缝制结束后是否回原点	是	NO: 否 YES: 是	
U8-6	缝制结束后回原点方式	XY 都找坐标原点	0: XY 都找坐标原点 1: X 通过传感器找原点, Y 通过传感器找原点 3: XY 都通过传感器找原点 4: 空送到传感器位置找原点	
U8-7	X 轴原点偏移	646	-3000-3000	1
U8-8	Y 轴原点偏移	-2.0	100.0-100.0	0.1
U8-9	切换到缝纫状态时 XY 是否找传感器原点	否	0: 否 1: 是	

U9 夹线器与拨线器

代码	简述	初始值	范围	步长/单位
U9-1	夹线器类型选择	机械	M: 机械 E: 电子	
U9-2	起缝前两针夹线器是否打开	关闭	OFF: 关闭 ON: 打开	
U9-3	空送前夹线器是否打开	关闭	OFF: 关闭 ON: 打开	
U9-4	夹线器打开保持电流	0	0-255	1
U9-5	起缝小夹线器是否打开	关闭	0: 关闭 1: 打开	
U9-6	拨线器类型	吹气拨线	0: 吹气拨线 1: 电磁铁拨线 2: 气缸拨线	
U9-7	吹气功能使能	剪线后打开	OFF: 关闭 ON1: 剪线后打开 ON2: 起缝前打开	
U9-8	剪线后吹气开始时间	0	0-200	1/10ms
U9-9	吹气持续时间	10	10-200	1/100ms
U9-10	电磁铁拨线打开持续时间	50	10-500	10/ms
U9-11	电磁铁拨线关闭持续时间	80	10-500	10/ms

U10 模板识别与压框

代码	简述	初始值	范围	步长/单位
U10-1	模板识别开关	打开	OFF: 关闭 ON: 打开	
U10-2	模板识别设备类型	RF 卡	BAR: 条码扫描设备 RF: RF 卡	

U10-3	压框降下后才允许识别模板	压框抬起降下均可识别	0-关闭:压框抬起降下均可识别 1-开启:压框降下后才能识别	
U10-4	缝制结束后的压框动作	先回原点再抬起	0: 先回原点再抬起 1: 先抬起再回原点 2: 回原点后踩踏板抬起	
U10-5	急停后是否允许压框抬起	禁止	OFF: 禁止 ON: 允许	

U11 换梭与切刀

代码	简述	初始值	范围	步长/单位
U11-1	自动换梭使能	关闭	OFF: 关闭 ON: 打开	
U11-2	梭盘电机零位补偿	0	-127-127	1
U11-3	换梭方式	底线报警后手动换梭	0: 底线报警后手动换梭 1: 底线报警后自动换梭	
U11-4	换梭起缝方式	手动启动	0: 手动启动 1: 自动启动	
U11-5	换梭停止位置	梭盘侧	0: 梭盘侧 1: 机头侧	
U11-6	空梭心处理方式	放回梭盘	0: 放回梭盘 1: 放收纳盒	
U11-7	机头对接位置修正补偿	0	-127-127	1
U11-8	换梭对接位置修正补偿	0	-127-127	1
U11-9	前后抓紧气缸到位延时	2000	0-20000	1
U11-10	夹紧气缸到位延时	500	0-20000	1
U11-11	抓臂电机工作电流档位	5	1-10	1
U11-12	旋转切刀使能	关闭	OFF: 关闭 ON: 打开	
U11-13	旋转切刀零位角度设置	0	-120-120	1
U11-14	切刀速度档位	3	1-10	1
U11-15	切刀旋转后等待时间	1000	0-20000	1
U11-16	切刀抬升后等待时间	3000	0-20000	1
U11-17	切刀电机工作电流档位	4	1-10	1
U11-18	直线切刀使能	关闭	OFF: 关闭 ON: 使能	
U11-19	直线切刀原点补偿	0	-127-127	1
U11-20	直线切刀下降高度	210	0-360	1
U11-21	直线切刀摆动幅度	80	10-100	1

U11-22	直线切刀同步延时	0	0-50	1
--------	----------	---	------	---

U12 维护与保养设置

代码	简述	初始值	范围	步长/单位
U12-1	缝制计数器计数单位	1	1-30	1
U12-2	注油间隔时间	30	0-65535	1/s
U12-3	注油工作时间	900	0-65535	1/ms
U12-4	禁止计数器被修改	允许修改	OFF: 允许修改 ON: 禁止修改	
U12-5	计数器达到设定值时缝纫机的操作	停止缝纫	OFF: 停止缝纫 ON: 可继续缝纫	
U12-6	油盒注油时间设置	84	0-9000	1/h
U12-7	保养油脂时间设置	360	0-9000	1/h
U12-8	底线报警设置	缝制中报警	0: 缝制中报警 1: 提前报警	
U12-9	油量油盒不足报警开关	关闭	OFF: 关闭 ON: 打开	

U13 面板设定

代码	简述	初始值	范围	步长/单位
U13-1	蜂鸣器声音设定	操作盘音+报警音	OFF: 无蜂鸣音 PAN: 操作盘音 ALL: 操作盘音+报警音	
U13-2	背光自动关闭	不自动关闭	OFF: 不自动关闭 ON: 自动关闭	
U13-3	背光自动关闭等待时间	3	1-9	1/m
U13-4	液晶背光亮度调节	100	20-100	1
U13-5	音量大小	50	30-63	1
U13-6	语音选择	中文	ZH: 中文 EN: English TU: 土耳其 HAN: 韩文 VIE: 越南	
U13-7	开机是否进入语言选择	否	OFF: 否 ON: 是	
U13-8	语音设定	关闭	OFF: 关闭 ON: 打开	
U13-9	主控烧录地址	851968	655360-917504 主控烧录地址: 0xA000:655360 0xB000:720896 0xC000:786432 0xD000:851968	1

			0xE000:917504	
U13-10	主界面图标文字模式切换	文字	ICON: 图标 WORD: 文字	
U13-11	网络设定	关闭	OFF: 关闭 WLAN0: WIFI ETH0: 有线	
U13-12	尺寸变更单位	百分比	%: 百分比 SIZ: 实际尺寸	
U13-13	放大缩小模式	间隔增减	OFF: 禁止 PIT: 间隔增减 STI: 针数增减	
U13-14	花样放大缩小方式	以原点为基准点	ORI1.: 以原点为基准点 ORI2.: 以原点为基准点 (忽略车缝前空送) CEN.: 以花样中心点为基准点 (忽略车缝前空送)	
U13-15	是否支持大针数花样	是	OFF: 否 ON: 是	
U13-16	语音识别功能设定	关闭	OFF: 关闭 ON: 打开	

U14 其他设置

代码	简述	初始值	范围	步长/单位
U14-1	缝纫模式	丝杠硬模式	SOF: 皮带软模式 DEF: 皮带防钻绒 HAR: 皮带硬模式 SOF2: 丝杠软模式 HAR2: 丝杠硬模式	
U14-2	机型选择	8	0: 标配机型 1: 中配机型 2: 高配机型 3: 自动机型 4: 900 机型 5: 直线切刀机型 6: 800 机型 7: 6037 机型 8: M6 丝杠模版机	1
U14-3	气压检测开关	打开	OFF: 关闭 ON: 打开	
U14-4	急停开关极性	常闭	OFF: 常闭 ON: 常开	
U14-5	移动界限+X 方向	650	0-2000	1/mm
U14-6	移动界限-X 方向	660	0-2000	1/mm

U14-7	移动界限+Y 方向	0	0-1000	1/mm
U14-8	移动界限-Y 方向	800	0-1000	1/mm
U14-9	恢复出厂参数	1	出厂默认参数 整机出厂参数 01(有)	
U14-10	启动方式设置	二次启动	NOR: 普通启动 TWO: 二次启动	
U14-11	缝制开始时到起缝点路径设置	按花样空送路径到起缝点	0: 直线到起缝点 1: 按花样空送路径到起缝点	
U14-12	开机是否直接进入可缝制状态	否	NO: 否 YES: 是	
U14-13	画笔 X 偏移	0	-500-500	1/mm
U14-14	画笔 Y 偏移	0	-500-500	1/mm
U14-15	画笔移动速度	1	1-9	1
U14-16	抓线是否打开	关闭	ON: 打开 OFF: 关闭	
U14-17	抓线抓紧位置	59	0-100	1
U14-18	抓线吸风时间	1	0-30	1
U14-19	抓线抓紧角度微调	-4	-100-100	1
U14-20	设定抓线的放开针数	2	1-7	1
U14-21	断线后回退开关	关闭	0: 关闭 1: 断线后回退开启: 回退不可以跨越空送 2: 短线后回退开启: 回退是允许跨越空送	
U14-22	断线后回退针数	5	1-50	1
U14-23	X 步距角微调	0	-100-100	1
U14-24	Y 步距角微调	0	-100-100	1

6 绕线

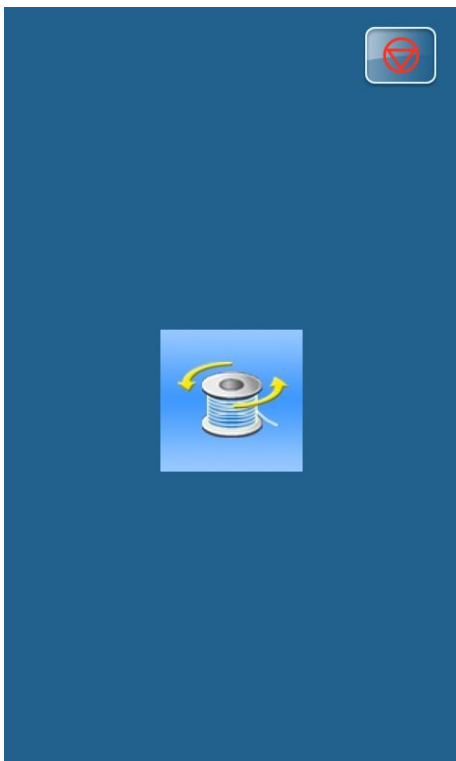

在【花样缝制】或【花样选择】界面，单击“绕线”，可进入【绕线】界面。

7 信息



需在花样选择界面按下“信息”键 ，缝制状态下需退出后才能进入。

可设置以下数值：

- 1) 更换机针计数
- 2) 更换机油计数
- 3) 清扫时间计数
- 4) 底线计数
- 5) 累积缝纫件数

7.1 分期密码

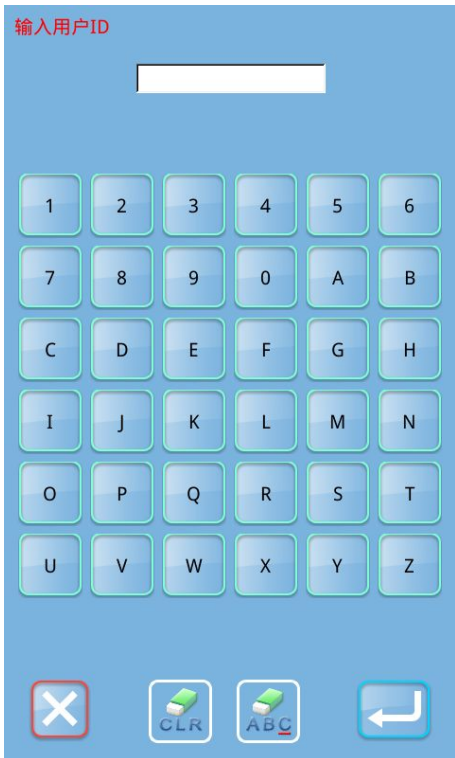

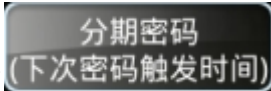
(1) 在【信息】界面下，单击“分期密码” ，首先会显示【输入用户 ID】界面，输入正确的厂家 ID 后即进入密码管理模式，主要用于用户分期密码的设置和管理。

- 可以最多设置 10 个不同的密码发作日期。
- 系统可以显示厂家设置的密码信息。



(2) 输入正确的厂家 ID 后，进入密码设置界面

设置密码前需要先设置板号和系统时钟，主要用于用户分期密码的设置和管理。

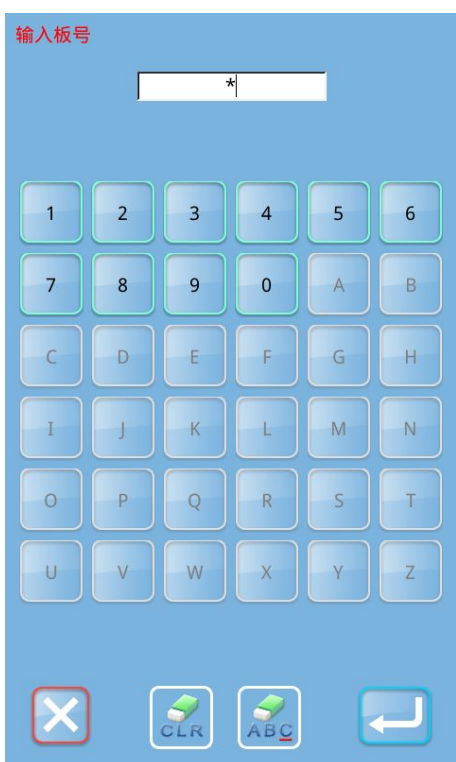

(3) 输入板号

按下“板号”键，进入【输入板号】界面，输入板号后，按

下确定键  完成输入。

※ 板号为四位，范围 0~9999



(4) 输入系统时钟

按下“时钟”键，进入【系统时钟设置】界面，确定系统时钟。



(5) 输入超级密码

按下“超级密码”键，进入【超级密码设置】界面，输入超级密码

※ 最多可输入 9 位总密码

※ 密码输入要求确认，两次密码必须一致

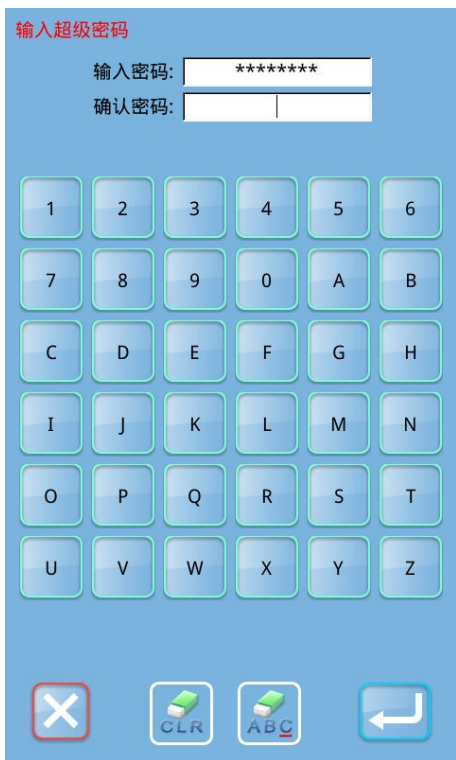

(6) 输入分期密码

按下【密码-1】键，进入第一期密码设置界面，要求输入第

一个有效日期，选择合适的日期后，按  确认。

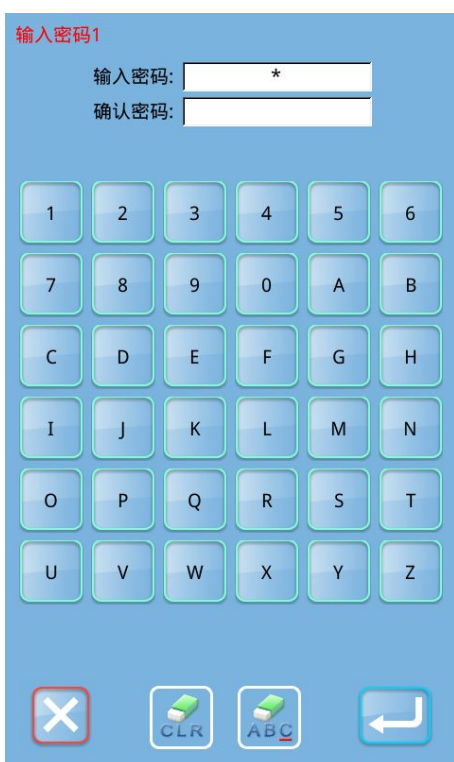

然后进入密码设置界面，输入密码。

※ 日期不能小于系统日期

※ 密码输入要求确认，两次密码必须一致

A screenshot of a settings screen with a blue background. It contains several input fields with labels in Chinese: '厂家' (Manufacturer) with a masked value '*****', '板号' (Board No.) with '0001', '时钟' (Clock) with '2019-08-24 15:26', '超级密码' (Super Password) with a masked value '*****', '密码-1' (Password-1) with '2019-08-25', and '密码-2' (Password-2) which is empty. At the bottom left is a red 'X' icon, and at the bottom right is a blue 'confirm' icon (a square with a white arrow pointing left and down).

1) 输入其他的分期密码

其他分期密码的设置和⑦相同，参考⑦的设置

※ 下一个有效日期必须大于上一个有效日期

2) 保存密码

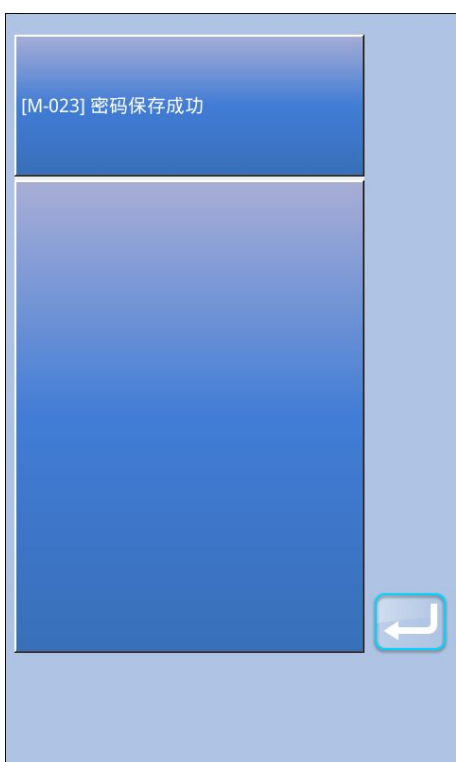

密码输入完成后，按确定键保存。密码保存成功后，会显示如右图所示提示信息。



3) 主动清除密码

主动清除密码是指在分期密码发作前主动清除密码的设置。

- A、进入方法同密码设置
- B、输入正确的厂家 ID 后，显示右边的界面
- C、系统显示当前时钟和各个分期密码发作日期



- D、按下 ，从前向后依次删除分期密码

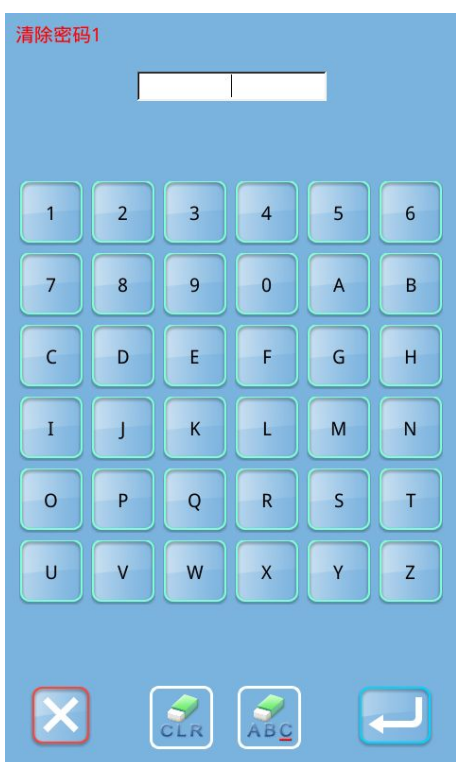

输入正确的分期密码后清除当前期的密码，当输入是超级密码时，则清除全部密码。

密码清除后会以红色文本形式显示，如果全部密码清除完毕，则自动退出，返回到信息主界面。

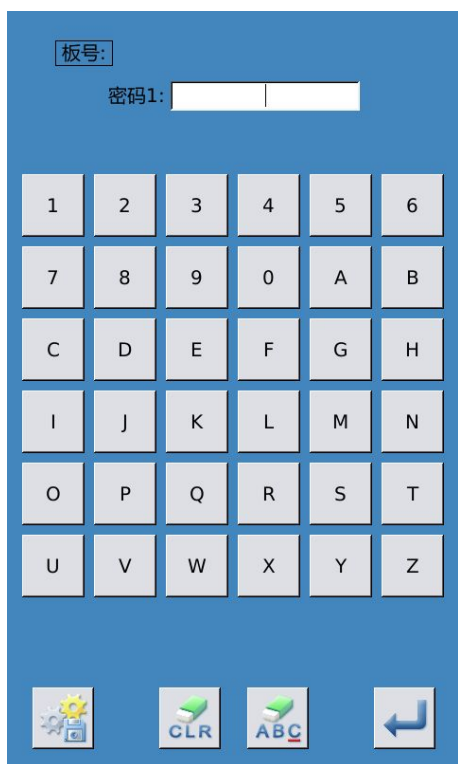

4) 密码发作

如果系统设置了密码，则使用至密码发作日期时，会遇到密码发作。

此时若继续使用，必须输入有效密码。

A、有效密码包括当期提示的密码和超级密码。

B、若输入的是当期密码，则清除当期密码。清除当前密码后，若后面没有密码，则机器不再会出现密码发作的问题。

C、若输入的是超级密码，则全部清除分期密码。

7.2 穿线示意

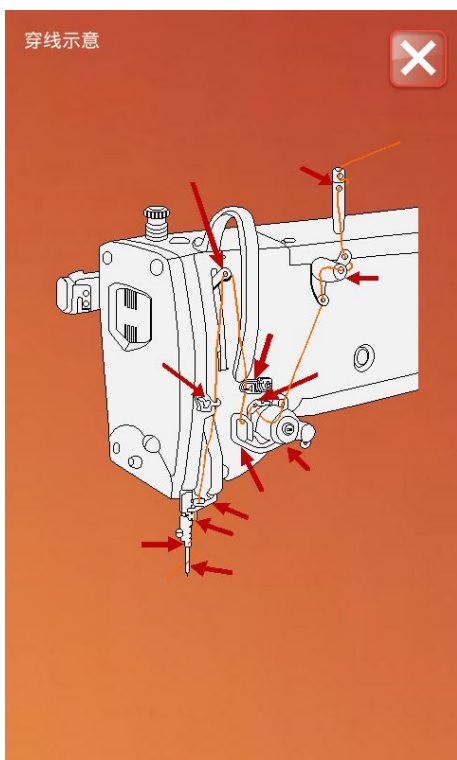

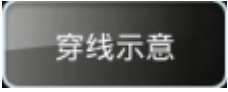
在【信息】界面下，单击“穿线示意”，进入【穿线示意】界面，穿线时，请参阅。

7.3 打卡

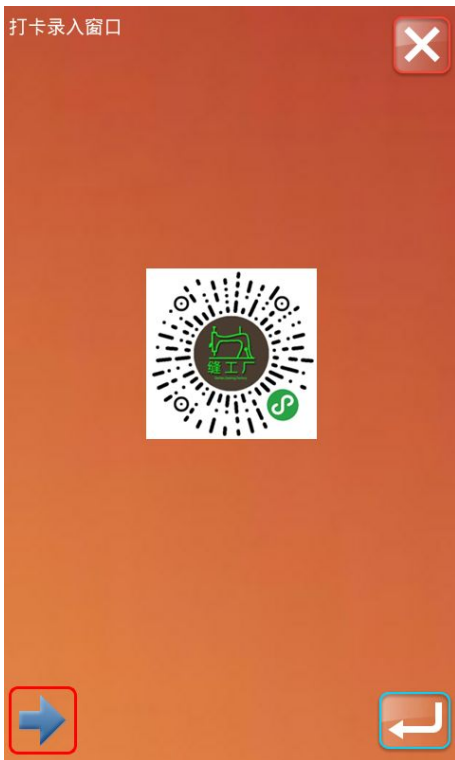

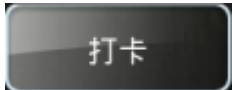
在【信息】界面下，单击“打卡”可进入智能打卡界面，如左图所示。

如果网络正常连接，员工可扫描图中二维码，进行打卡；

或者单击“切换”键，切换打卡方式，员工可录入自己的工号，点击确定键可以将自己的信息发送给服务器。

如果智能工厂服务器保存有相关的员工信息，此时员工的相关工作统计会记入服务器。

管理人员通过智能工厂客户端查询相关工作统计可以轻松结算员工产量、工资等信息。

注意：带 WIFI 功能的面板才能正常使用该功能。

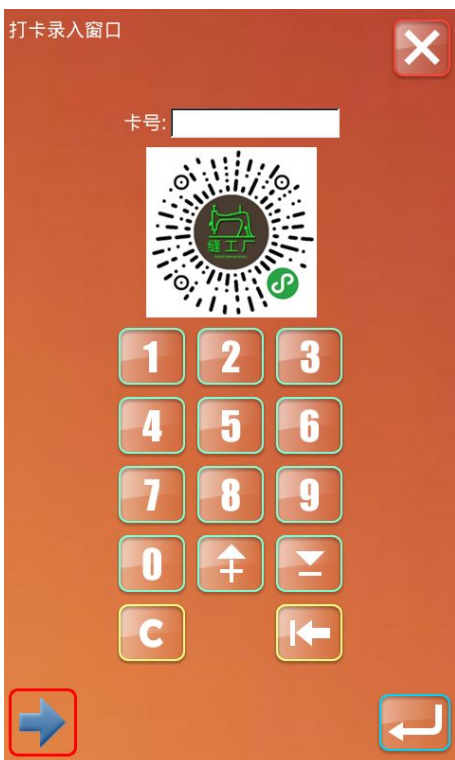

7.4 生产管理参数

详见 [6.5 维护与保养设置](#)

7.5 加减计数器

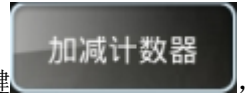

在【信息】界面下，按下“加减计数器”键，进入【计数器】设置界面。

缝制计数器：每缝制 1 件缝制物，计数器加/减 1。

计件计数器：每缝制 1 循环，计数器加/减 1。

计件计数器主要是针对 C 花样计数的，如果使用其他缝纫类型，计件计数器和缝制计数器作用相同。

1) 计数器数值设置

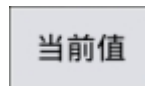

：按下后可以设置计数器当前值。



：按下后可以设置计数器设定值，设定值为 0 时，计数器不起作用。

2) 计数器类型设置



：设置为加计数器类型，当当前值达到设定值时会提示报警。



：设置为减计数器类型，当当前值为 0 时会提示报警。



：关闭计数器功能。

注 1：参数 U12-4：禁止计数器被修改，设置为“禁止修改”时不能够进入该界面。

注 2：参数 U12-5：计数器到达设定值时缝纫机的操作，设置为“可继续缝纫”时计数器当前值溢出后不报警，会自动恢复为目标值（加计数器恢复为 0，减计数器恢复为设定值）。

7.6 运转记录



在【信息】界面下，按下“运转记录”键

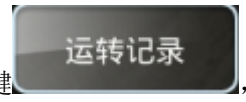

- 累积运转时间：记录机器累积运转时间（小时单位）
- 累积缝纫件数：记录机器累积缝制件数
- 累积上电时间：机器累积上电时间（小时单位）
- 累积缝纫针数：机器累积针数（1000 针单位）



按下“清除”键可以分别清除记录值。

7.7 报警记录



在【信息】界面下，按下“报警记录”键

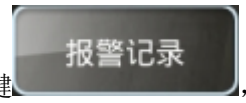

界面中显示了系统发生的故障信息内容，序号越小表示该故障信息发生的时间越新。另外还记录了每次报警发生时的生产计数。



可以通过 键或 键进行翻页，查看更多的报错信息。

按下  键会清除掉全部故障信息记录。

7.8 错误上报



在【信息】界面下，按下“错误上报”键

进入【错误上报】界面。

可通过单击，选择机器状态：

- 1) 设备故障
- 2) 尺寸
- 3) 接收物料
- 4) 抛线
- 5) 等待模板
- 6) 跳针
- 7) 等待物料
- 8) 球线
- 9) 换线调试

： 上报机器状态

： 错误解决后，可单击结案

8 附录 1

8.1 报警信息一览表

故障号	故障名称	复位方法
E001	踏板未在正确位置	请调整踏板位置
E002	机器进入急停状态	请检查急停开关状态
E003	确认机头放倒	自恢复错误
E004	主电压（300V）过低	请关闭电源，检查系统硬件
E005	主电压（300V）过高	自恢复错误
E007	IPM 过压或过流	请关闭电源，检查系统硬件
E008	辅助设备电压（24V）过高	请关闭电源，检查系统硬件
E009	辅助设备电压（24V）过低	请关闭电源，检查系统硬件
E010	气阀短路或风扇堵转	请关闭电源，检查系统硬件
E011	X 电机超速故障	请关闭电源，检查系统硬件
E012	X 电机超差故障	请关闭电源，检查系统硬件
E013	编码器故障或未连	请关闭电源，检查系统硬件
E014	电机运行异常	请关闭电源，检查系统硬件
E015	移动过程中超出缝制范围	请按下确定键解除故障
E016	针杆上位置异常	请按下确定键解除故障
E017	断线检测错误	请按下确定键解除故障
E018	剪线刀位置异常	请关闭电源
E019	急停开关未在正常位置	请检查急停开关
E020	步进软件版本错误	请关闭电源
E023	抓线位置异常	请关闭电源
E024	操作头与缝纫机连接错误	请关闭电源
E025	X 原点检测异常	请关闭电源
E026	Y 原点检测异常	请关闭电源
E027	压脚原点检测异常	请关闭电源
E028	抓线原点检测异常	请关闭电源
E029	中压脚原点检测异常	请关闭电源
E030	步进驱动器通讯异常	请关闭电源
E031	X 轴电机过流	请关闭电源
E032	步进驱动电源异常	请关闭电源
E034	异常电流	请关闭电源
E035	IPM 频繁过流 1	请关闭电源
E036	IPM 频繁过流 2	请关闭电源
E037	电机堵转 1	请关闭电源
E038	电机堵转 2	请关闭电源
E039	电机超速	请关闭电源
E040	停车过流	请关闭电源
E041	电机过载	请关闭电源

故障号	故障名称	复位方法
E042	母线电压异常	请关闭电源
E043	Y 电机超速故障	请关闭电源, 检查系统硬件
E044	Y 电机超差故障	请关闭电源, 检查系统硬件
E045	底线计数不足	更换底线设定值已到达, 请更换底线
E046	中压脚电机过流	请关闭电源, 检查系统硬件
E047	Y 电机过流	请关闭电源, 检查系统硬件
E048	气压不足	请检查气路是否正常
E049	换梭机械臂电机原点信号错误	请关闭电源, 检查系统硬件
E050	梭盘电机原点信号错误	请关闭电源, 检查系统硬件
E051	梭盘为空	检查梭盘检测器, 装填梭盘
E052	步进驱动升级失败	
E053	X 电机大电流	
E054	Y 电机大电流	
E055	快走曲线计算错误	
E056	SPI 通信结束码异常	
E057	SPI 通信校验失败	
E058	快走接收数据异常	
E059	x 电机堵转	
E060	y 电机堵转	
E061	X 电机指令覆盖	
E062	Y 电机指令覆盖	
E063	X 电机快走指令覆盖	
E064	Y 电机快走指令覆盖	
E065	动框曲线计算异常	
E066	X 电机过流	
E067	抓线电机过流	
E068	切刀电机原点位置异常	
E069	急停坐标异常	
E070	停车等待超时	
E071	切刀电机超差	
E080	油盒油量不足,请添加润滑油	
E081	主控花样接收异常	
E090	步进电机 3 通讯异常	请关闭电源
E097	RF 读写异常	请关闭电源
E098	激光安全开关位置异常	请检查安全开关
E099	切刀提升异常	请关闭电源
E100	切刀伺服电机动作异常	请关闭电源
E101	剪线电机原点异常	请关闭电源
E102	剪线电机超差	请关闭电源
E103	剪线电机过流	请关闭电源
E254	未定义错误	通讯出现未定义错误

8.2 信息提示一览表

信息号	信息名称	子信息内容
M-001	花样数据不存在	请重新读取或打版输入
M-002	设置值太大	请输入范围内数值
M-003	设置值太小	请输入范围内数值
M-004	存储参数异常	请按下确定键恢复出厂设置
M-005	通讯错误	操作头与控制箱通讯异常
M-006	请退出缝制状态	
M-007	操作头与控制箱类型不符	请核对机型和软件版本
M-008	超出最大针距	
M-009	密码错误	请重新输入
M-010	硬件时钟故障	发现硬件时钟故障，请联系厂家维修
M-011	请解除锁定	
M-012	SRAM 初始化	清除掉 SRAM 中全部数据，请关电并将拨码开关位置还原
M-013	关机，再见	
M-014	USB 盘已拔出	USB 盘已经拔出
M-015	U 盘中没有发现花样数据	
M-016	至少输入一个字母	字母绣打版需要至少输入一个字母！
M-017	无报警记录	
M-018	输入用户 ID 有误	请重新输入
M-019	确认密码失败	请重新输入密码
M-020	禁止修改系统时间	设置了分期密码，不能修改系统时间
M-021	密码文件写入失败	
M-022	密码文件读取失败	
M-023	密码保存成功	
M-024	清除全部密码失败	密码文件无法被删除
M-025	清除密码失败	清除密码后，文件写入异常
M-026	密码文件被恶意删除	用户设置的分期密码被恶意删除，请关机
M-027	用户 ID 文件损坏	
M-028	输入不能为空	请输入密码
M-029	当前密码不符	请重新输入当前密码
M-030	新密码不一致	请重新输入新密码并再次确认
M-031	确定进入触摸屏校正模式	其否确定？是：enter 否：X
M-032	触摸屏校正成功	校正成功，请关闭电源后重启
M-033	触摸屏校正失败	请重新校正
M-034	确定清除报警记录	其否确定？是：enter 否：X
M-035	分期密码不能和总密码相同	请重新输入密码
M-036	花样数据错误	当前花样数据错误，将由出厂花样替换！
M-037	花样信息文件打开失败	恢复出厂花样配置！
M-038	花样个数已满	请删除不用的花样后再执行操作！

M-039	是否覆盖花样	其否确定？是：enter 否：X
M-040	P 花样打开失败	花样文件错误，将会被删除
M-041	C 花样打开失败	花样文件错误，将会被删除
M-042	花样已存在	不能执行覆盖操作
M-043	是否删除花样数据	按下确定键执行删除操作，按下取消键退出当前操作。
M-044	是否删除选中的文件	其否确定？是：enter 否：X
M-045	花样被引用，不能删除!	请在 P 花样或 C 花样中解除引用
M-046	请至少保留一个花样!	最后一个花样不能被删除
M-047	加载出厂花样	内存中没有花样，需要加载出厂花样
M-048	内存中没有花样	按确定键加载出厂花样
M-049	输入号码不存在	请重新输入
M-050	P 花样不存在	请先创建 P 花样
M-051	保存软件版本成功	软件版本已经成功保存到 U 盘根目录下
M-052	更换机针	更换机针设定值已到达，请更换机针
M-053	更换机油	更换机油时间设定值已到达，请更换机油
M-054	清扫机器	清扫机器时间设定值已到达，请清扫机器
M-055	确定清除更换机针计数值	其否确定？是：enter 否：X
M-056	确定清除更换机油计数值	其否确定？是：enter 否：X
M-057	确定清除清扫时间计数值	其否确定？是：enter 否：X
M-058	确定清除生产管理计数值	其否确定？是：enter 否：X
M-059	确定清除累积运转时间?	其否确定？是：enter 否：X
M-060	确定清除累积缝纫件数?	其否确定？是：enter 否：X
M-061	确定清除累积上电时间?	其否确定？是：enter 否：X
M-062	确定清除累积缝纫针数?	其否确定？是：enter 否：X
M-063	确定清除累积过流次数?	其否确定？是：enter 否：X
M-064	确定清除累积停车错误次数?	其否确定？是：enter 否：X
M-065	是否编辑新花样?	其否确定？是：enter 否：X
M-066	是否返回缝制模式?	其否确定？是：enter 否：X
M-067	是否还原所有设定	其否确定？是：enter 否：X
M-068	是否还原选择项目	其否确定？是：enter 否：X
M-069	未选择项目	请选择一个或几个参数项
M-070	缝制计数器达到设定值	请按下确定键清除
M-071	计件计数器达到设定值	请按下确定键清除
M-072	成功	已成功执行当前操作
M-073	失败	当前操作执行失败
M-074	拷贝文件失败	请检查磁盘空间是否已满
M-075	拷贝文件失败	请检查是否拔出了 USB 盘
M-076	文件读写错误	文件读写错误
M-077	升级主控程序时校验失败	
M-078	花样数据不能删除	被选中的缝制数据正在使用
M-079	是否执行参数传输操作	其否确定？是：enter 否：X
M-080	转换花样无法打开	请确认花样文件

M-081	转换花样格式错误	请确认花样文件
M-082	转换花样数据超长	请确认花样文件
M-083	升级成功	升级成功，请重新启动机器
M-084	打开文件失败	U 盘中打开文件失败
M-085	恢复参数成功	恢复参数成功，请重新启动机器
M-086	没有选中升级条目	请选中要升级的条目，至少要选中一个条目
M-087	选中的升级条目中有些不存在	不存在升级文件的条目返回后将会取消选中，如果要升级剩下的条目，请再次确认
M-088	是否格式化 U 盘	按下确定键执行格式化操作，按下取消键退出当前操作。格式化后会删除全部 U 盘文件！
M-089	是否格式化内存	按下确定键执行格式化操作，按下取消键退出当前操作。格式化后会删除全部内存花样数据！
M-090	内存空间不足	
M-091	不能选择该功能	
M-092	制定的形状点重复	
M-093	不能执行回退操作	
M-094	没有下一针缝制数据	
M-095	没有上一针缝制数据	
M-096	花样数据太大	
M-097	运算异常	
M-098	打版通用错误	
M-099	花样不存在	
M-100	超过移动范围	
M-101	超出缝制范围	请确保花样数据在缝制范围以内
M-102	针数超出范围	请减少花样针数
M-103	花样文件数据错误	
M-104	确认点改变	
M-105	确认自动插入剪线	
M-106	删除新编辑花样	确定键确认，退出键取消
M-107	删除要素	确定键确认，退出键取消
M-108	执行，确认吗？	确定键确认，退出键取消
M-109	删除机械控制命令？	确定键确认，退出键取消
M-110	删除落针点	确定键确认，退出键取消
M-111	移动压脚，确认吗？	确定键确认，退出键取消
M-112	删除形状点	确定键确认，退出键取消
M-113	警告：格式化将删除磁盘上的所有数据！	确定键确认，退出键取消
M-114	请关机	当前操作结束，请重新启动机器
M-115	禁止修改计数器	当修改时，请关闭设定
M-116	是否恢复出厂设置	确定键执行操作，取消键退出操作
M-117	是否清除全部自定参数	是否确定？是：enter 否：X
M-118	花样计算错误	

M-119	是否删除全部 P 花样和 C 花样	按下确定键执行格式化操作，按下取消键退出当前操作。
M-120	超出设定值范围	
M-121	外压脚在上	当前操作需要落下外压脚后执行!
M-122	不能进行正确操作	
M-123	USB 盘不存在	请插入包含 mp3 文件的 USB 盘
M-124	没有视频文件 video.avi	请将 video.avi 文件存放到盘的 update 目录，并进入到升级界面升级视频文件
M-125	更换底线	更换底线设定值已到达，请更换底线。
M-126	确定清除底线计数值?	是否确定? 是: enter 否: X
M-127	底线不足	请更换底线，按下确定键后重新计数
M-128	模板花样不存在	请退出后，按回原点键并更换模板花样
M-129	花样名文件与花样不匹配	按确定键后重新加载,花样越多,耗费时间越长
M-130	升级文件长度错误	
M-131	升级主控擦除校验错误	
M-132	升级主控写校验错误	
M-133	升级主控结束校验错误	
M-134	是否保存为新花样	确定键执行操作，取消键退出操作 保存为新花样后,原花样不再改变
M-135	网络连接失败	
M-136	打卡成功	
M-137	打卡失败	
M-138	确认修改网络功能，请关闭电源后重启	网络功能将在系统重启后加载
M-139	油盒注油提醒	请检查大油盒油量，并注入适当的油
M-140	保养油脂提醒	请检查各保养部件，并添加适当的油脂(具体操作请参考保养手册)
M-141	升级步进结束校验错误	
M-142	校正基准点没有落在花样上对应位置,继续操作会导致花样发生缩放，是否继续操作	确定键执行操作，取消键退出操作
M-143	起缝点超出安全位置，无法修改起缝点	
M-144	缝制中针位坐标与花样不符	
M-145	二维码显示失败	
M-146	分组号无效	
M-147	拒绝当前操作	
M-148	接收参数为空	
M-149	参数未发生变化	
M-150	面板与主控不匹配	当前系统存在分期密码，需要联系厂家解除锁定!
M-151	当前面板存在密码，需要同步	面板存在密码，主控没有密码!
M-152	当前主控存在密码，需要同步	主控存在密码，面板没有密码!
M-153	主板 ID 不存在	

M-154	面板未加密,主控加密	系统会锁机
M-155	面板加密,主控未加密	确定键同步加密状态
M-156	系统已经存在远程分期设置	确定键继续操作, 取消键退出操作
M-157	无线模块 1 联接失败	系统转速降至最低, 请联系厂家
M-158	系统已经设置为不联网模式	打开联网功能后可以进行检测
M-159	联接失败	
M-160	不能执行换机操作	参数和花样至少需要选中一个
M-161	换机成功	参数或者花样已经成功覆盖本机,需要关机重启
M-162	是否立即更新花样缩略图?	花样使用后也会同时生成缩略图
M-163	花样不存在, 是否从服务器下载	是否确定? 是: Enter 否: X
M-164	请求花样不是标准 VDT 格式	
M-165	服务器不存在请求花样	
M-166	服务器更新软件, 是否进行升级操作	是否立刻升级? 是: Enter 否: X
M-167	请求失败	
M-168	确认修改用户定制参数	是否确定? 是: Enter 否: X
M-169	参数修改生效需要解除锁定	是否解锁? 是: Enter 否: X

9 附录 2

9.1 电控箱连接示意图



图 1 电控箱连接示意图

9.2 操作箱示意图

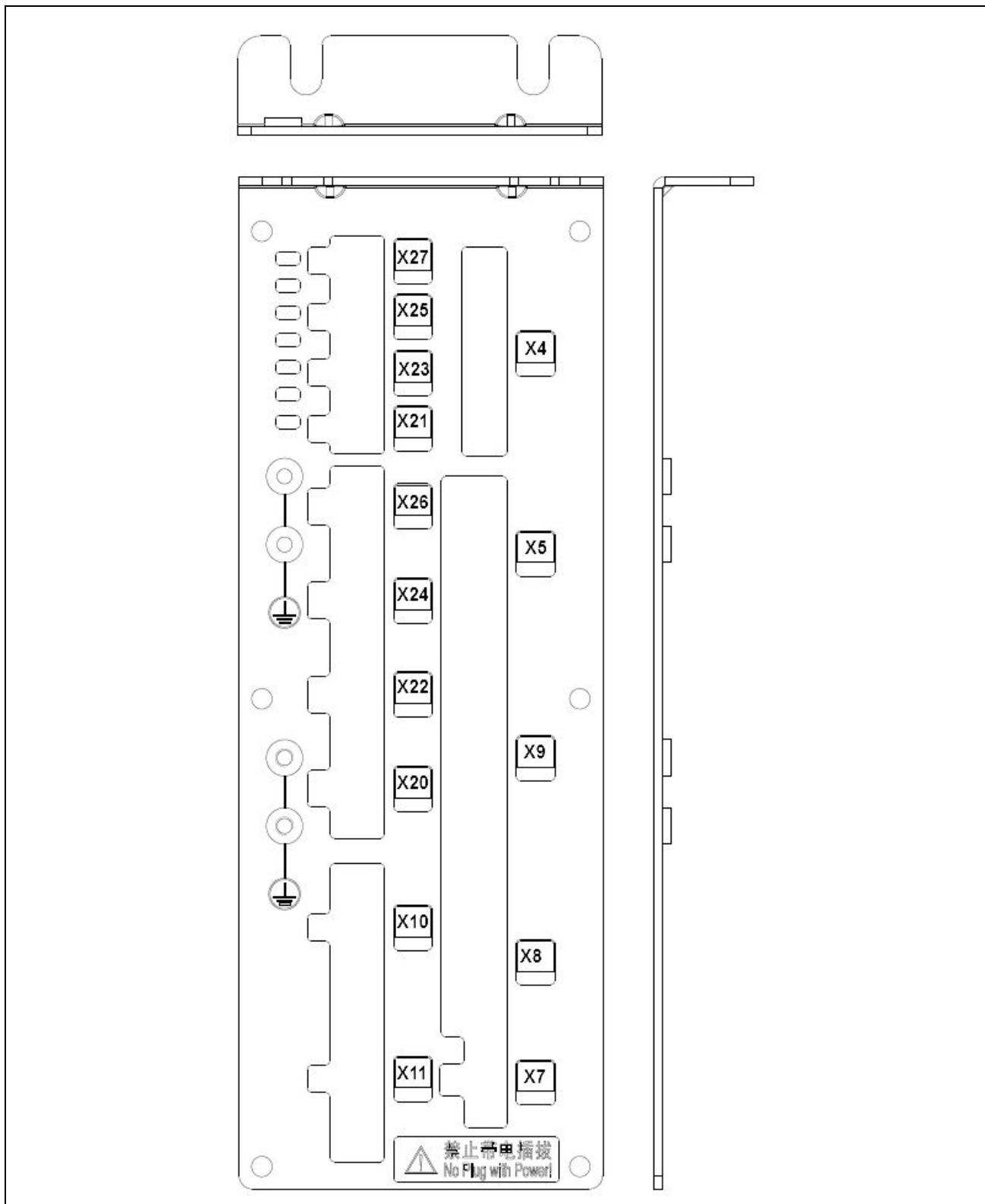

图 2 操作箱示意图

9.3 系统框图

MHSC4056-2E2/B-MBJ 三丝杠模板机

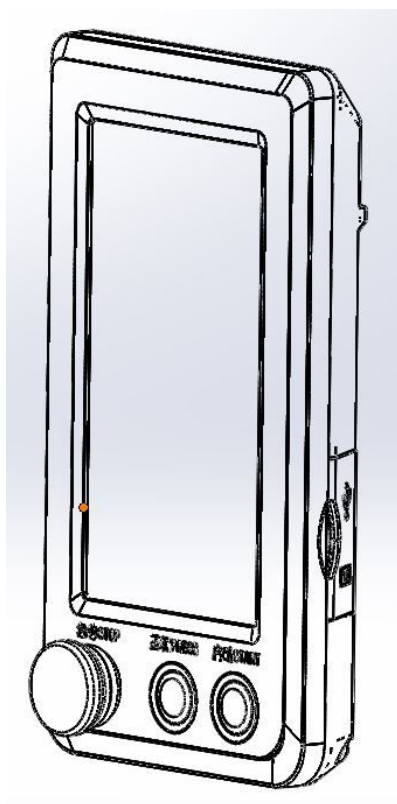
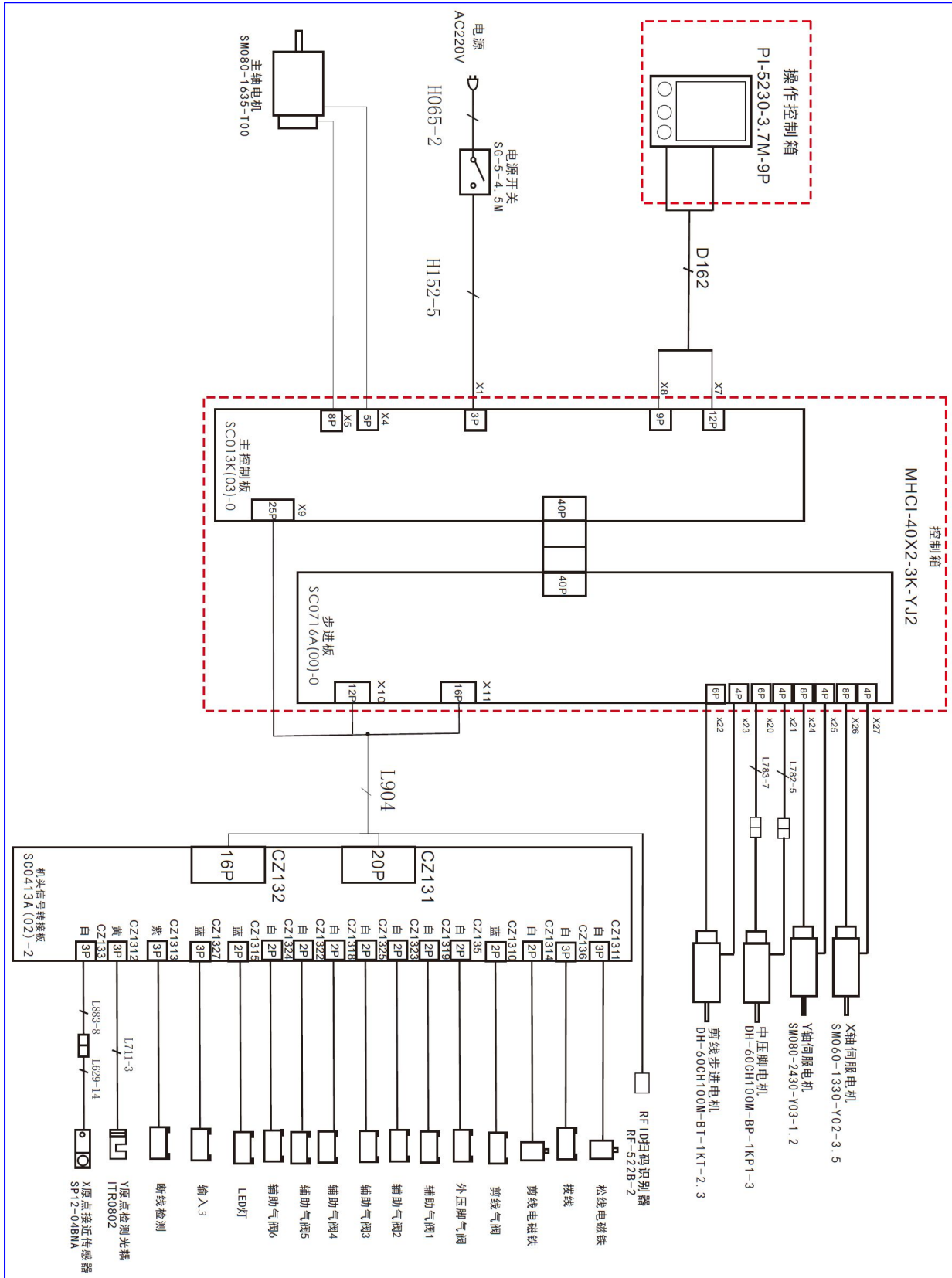

1 General Introduction

1.1 General

Automatic template machine series industrial sewing machine computer control system, spindle motor with the world's advanced level of ac servo control technology drive, with large torque, high efficiency, speed stability and low noise characteristics. The diversified design of operation panel can meet the matching requirements of different customers; The system adopts German structure design, easy to install and maintain, the system control software can be upgraded through remote communication, convenient for users to improve the product performance.

1.2 Functions & Specifications

NO.	Type of Controller	ASC400 Computerized Control System for Pattern Sewing Machine
1	Sewing Range	X(Left/Right) Y (Front/Back) 1300 x 800
2	Max Sewing Speed	3200rpm (when sewing pitch is below 3mm)
3	Stitch Length	0.1~12.7mm (Min. Resolution : 0.05mm)
4	Presser Feeding Motion	Intermittent Feed (2-shaft drive by stepping motor)
5	Stroke of Needle Bar	41.2mm
6	Needles	DP×5、 DP×17
7	Lift of Feeding Frame	Max 25mm (Pneumatic type: Max 30mm)
8	Intermediate Presser Stroke	Standard 4mm (0~10mm)
9	Lift of Intermediate Presser	20mm
10	Shuttle	Double-capacity semi-rotary hook
11	Memory of Pattern Data	U Disk
12	Pause Function	Used to stop machine during the sewing
13	Scale Function	Enable a pattern to be enlarged or reduced in X or Y direction individually when sewing a pattern Scale: 1%~400% (adjust 0.1% in each step)
14	Scale Method	Method for changing the length of each sewing stitch
15	Limitation of Sewing Speed	200~3200rpm (change 100rpm in each step)
16	Function for Selecting Pattern	Pattern Number Selection Method
17	Bottom Thread Counter	Up/Down Method (0~65535)
18	Sewing Counter	Up/Down Method (0~9999)
19	Setting of 2 nd Origin	Use manual switch to move the needle to a random position within the sewing range and set that position as 2 nd origin.
20	Sewing Motor	Servo Motor
21	Function of stopping needle at highest position	After the completion of sewing, the needle can be brought up to its highest position.
22	Power Consumption	600W
23	Operation Temperature Range	0℃~45℃
24	Operation Humidity Range	35%~85% (No Dew Condensation)
25	Line Voltage	AC 220V ± 10%; 50/60Hz

※ Effective standard for product:QCYXDK0004—2016 《Computerized Control System for Industrial Sewing Machine》.

1.3 The main interface

After starting up, the machine will directly enter the interface of pattern selection. Click  to enter the interface of pattern sewing.

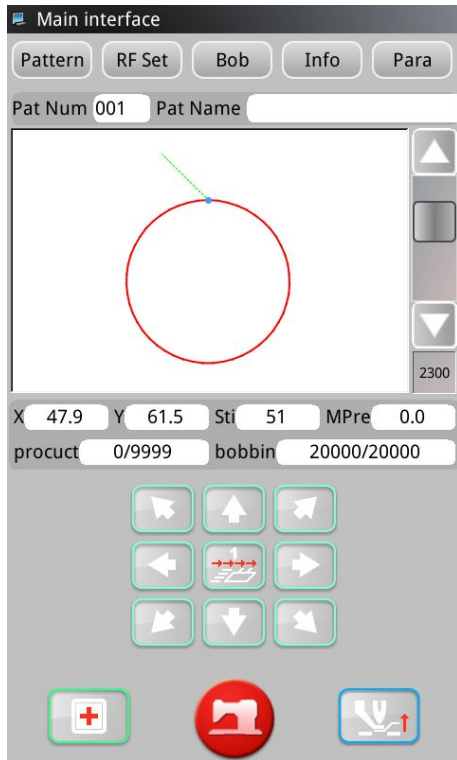

Pattern selection interface

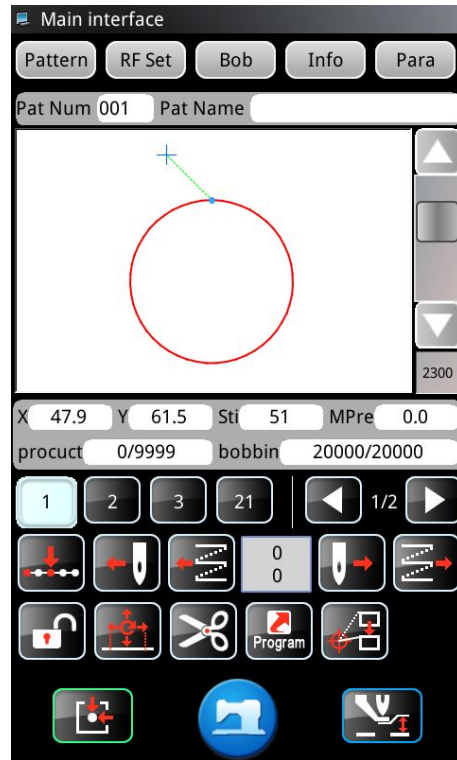

Pattern sewing interface

1.4 Operation Method

The touch screen operation panel adopts the advanced touch operation technology in the industry, integrates the pressing frame of the pedal, the solid buttons of the start and emergency stop switch functions, and the friendly interface and convenient control all bring revolutionary changes to the daily use of users. The user can touch the screen with a finger or other object to complete the corresponding operation. Users should pay attention to avoid using sharp objects to touch the screen in the process of use, so as to avoid permanent damage to the touch screen

1.5 Quick introduction to sewing

Boot will be directly into the [pattern selection] interface.

Click the "pattern management" key  in the interface of "pattern selection" to enter the interface of "pattern reading".

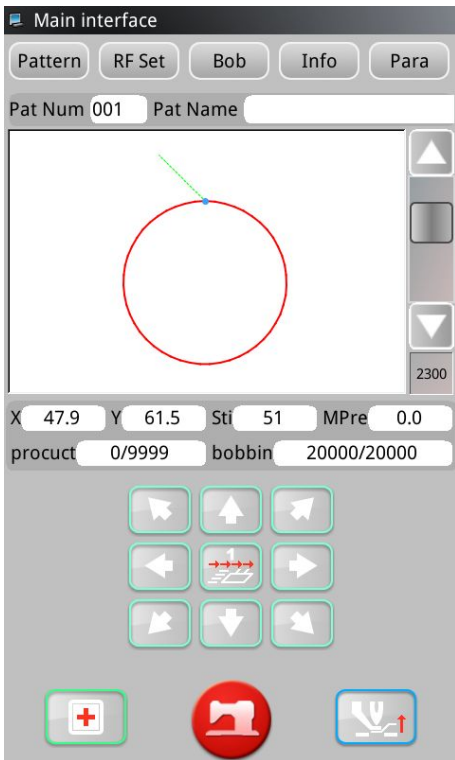

In the "read pattern" interface, you can select the pattern you want to sew.



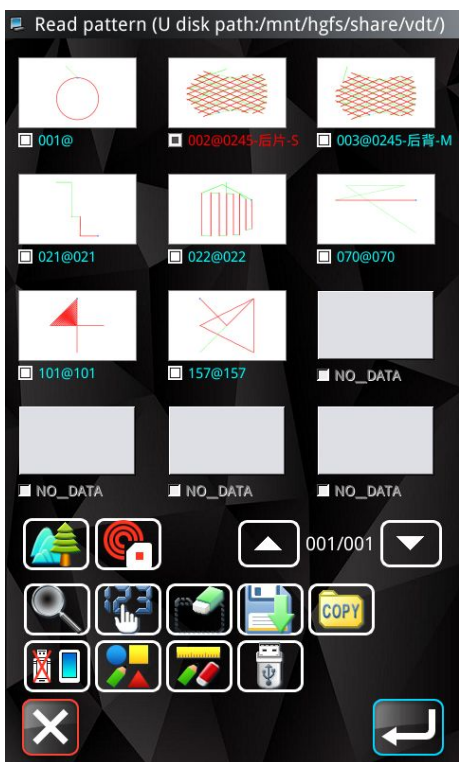



Click the pattern you want to sew in the "read pattern" interface and select the pattern.

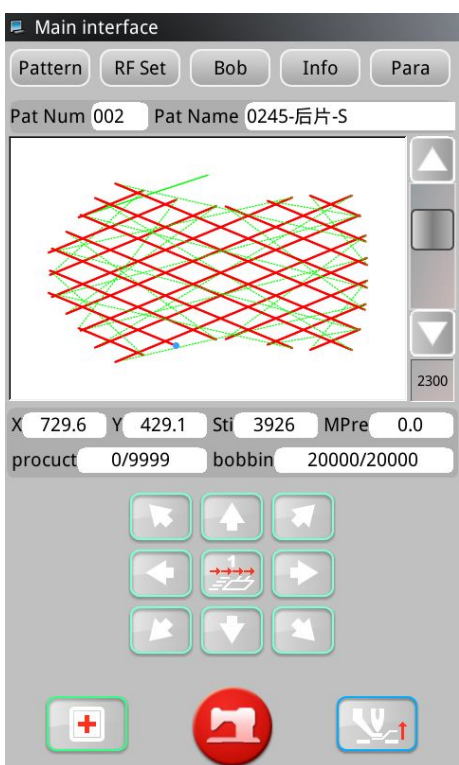

Click enter to confirm the pattern and return to the pattern selection screen automatically.



In the "pattern selection" interface, click  to enter the "pattern sewing" interface.

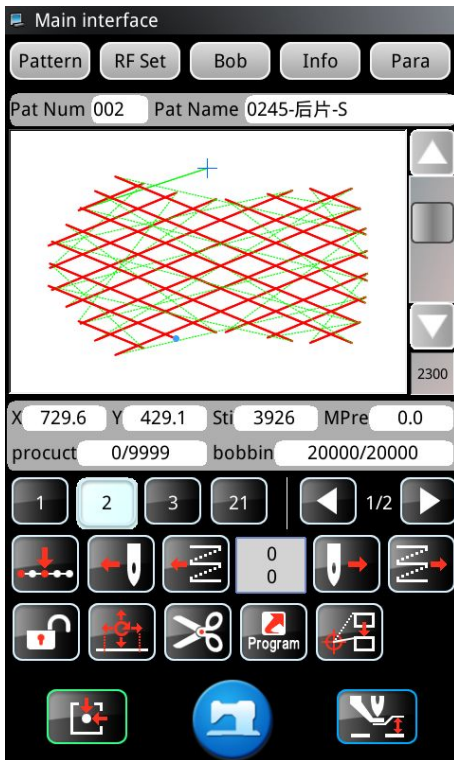

In the interface of pattern sewing, the pattern parameters can be set.

After setting the pattern parameters, put the corresponding template in place, first press the "press box" button on the operation head, and then press the "start" button. After confirming the correct position of the sewing point, press the "start" button for the second time to start sewing.

2 Pattern selection interface

After booting, it will directly enter the interface of pattern selection and display basic parameters of pattern.

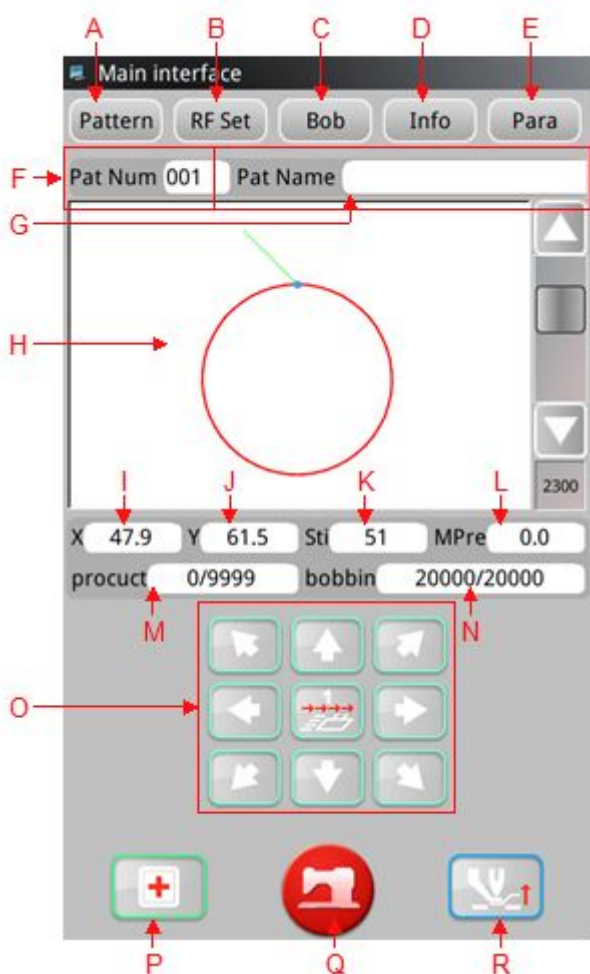

No.	Function	Description
A	Design management	Can choose, set pattern parameters, etc
B	The RF registration	The current pattern can be written to the RF card
C	Winding.	Enter winding mode
D	information	You can view the action header statistics class information
E	Set up the	User parameters can be set
F	Figure no.	Displays the current pattern number
G	Pattern name	Displays the current pattern name
H	Pattern preview area	Click the pattern preview area to view basic pattern information and preview patterns
I	X-direction range	Displays the current pattern X direction range
J	Y-direction	Displays the current pattern Y direction range

	range	
K	Needle numerical	Displays the total number of current pattern drop points
L	Medium pressure foot value	Displays the height of the current pattern middle pressure foot
M	Production count	Displays the current/set value of the production counter
N	Bottom line count	Displays the bottom line count
O	Move the box	Movable frame
P	detection	Can enter detection mode, detect input and output and other signals
Q	switch	The pattern sewing interface and pattern selection interface switch to each other
R	Medium pressure foot	Lift or lower middle pressure foot

2.1 Pattern preview

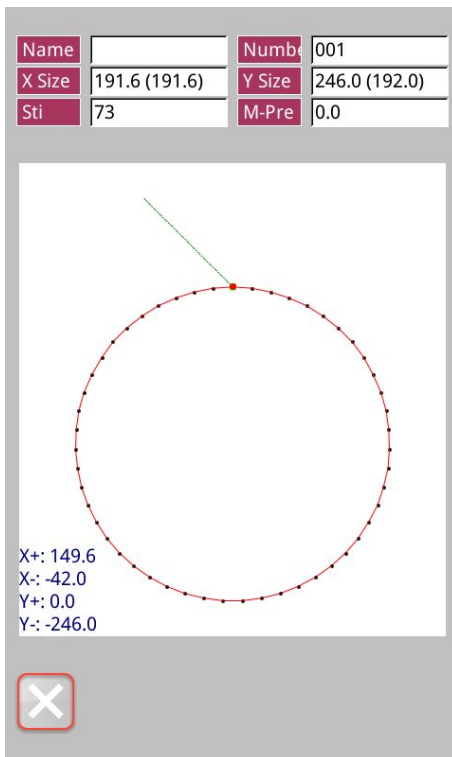

In the interface of "pattern selection" or "pattern sewing", click the pattern preview area to enter the interface of "pattern preview" and display the following information:

- ① pattern name
- ② the figure number
- ③ X size
- ④ Y size
- ⑤ pin number
- ⑥ medium pressure foot height
- ⑦ pattern coordinates

2.2 Test Mode

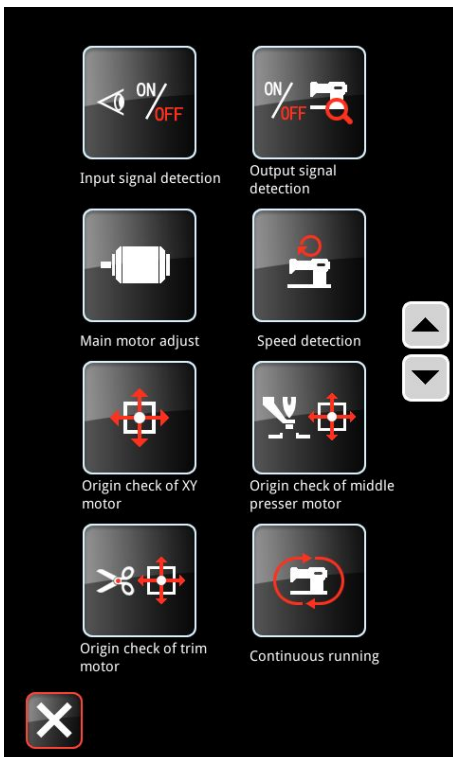

In the interface of "pattern selection", click "detect"  to enter the interface of "detect" and turn the page through the

up and  down  page turning key.

- 15) input signal detection
- 16) output signal detection
- 17) spindle motor calibration
- 18) speed detection
- 19) XY motor origin detection
- 20) medium pressure foot motor detection
- 21) detection of wire cutting motor
- 22) Continuous operation

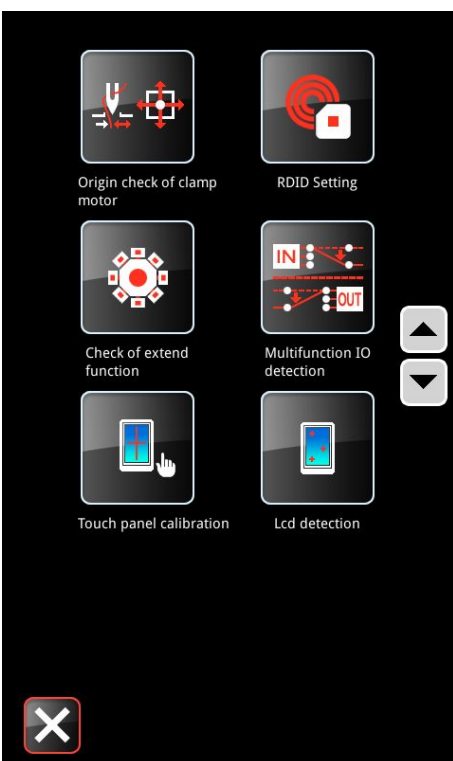

- 9) wire grasping motor detection
- 10) RFID setting
- 11) extended function detection
- 12) multi-function IO detection
- 13) touch screen calibration
- 14) liquid crystal detection

2.2.1 Input signal detection

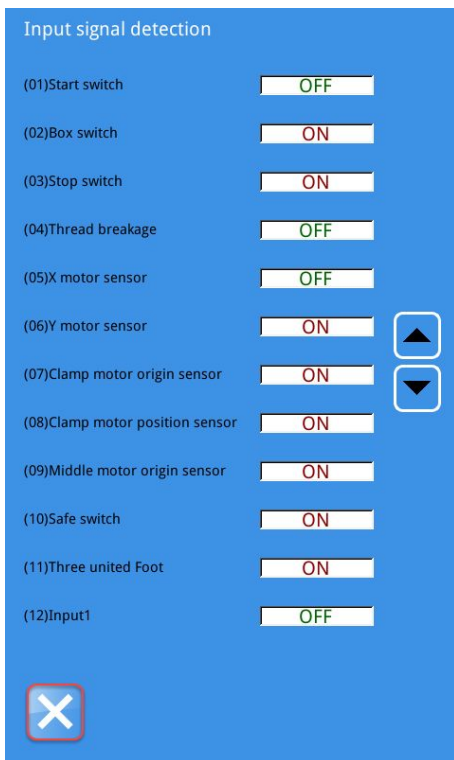

In the interface of "detection", click "input signal detection"



to enter the interface of "input signal detection". You can observe the changes of input signals of various switches and sensors by pressing down the switch or blocking sensor.

ON: means open

OFF: means close

0: represents the number entered by barcode scanning. The

default value is 0

Display current input signal status:

- (01) start button
- (02) push box button
- (03) emergency stop button
- (04) broken line detection
- (05) X origin sensor
- (06) Y origin sensor
- (07) grab wire origin sensor
- (08) grab the line position sensor
- (09) middle pressure foot origin sensor
- (10) safety switch
- (11) triple pedal test
- (12) Enter 1

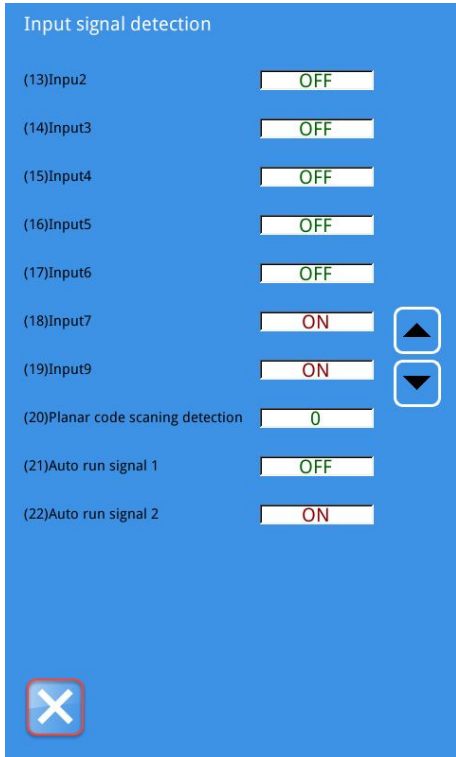

- (13) Enter 2
- (14) Enter 3
- (15) Enter 4
- (16) Enter 5
- (17) Enter 6
- (18) Enter 7
- (19) Enter 8
- (20) barcode scanning and detection
- (21) self-starting signal 1
- (22) self-starting signal 2

2.2.2 Output signal detection

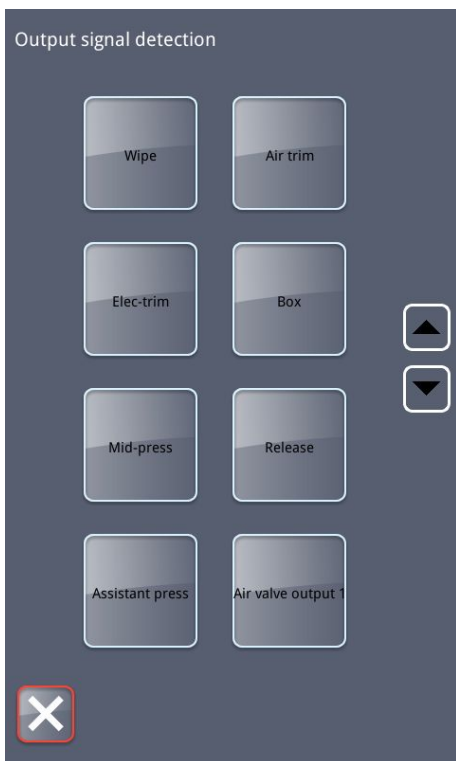

In the [detection] interface, click "output signal detection"



to enter the [output signal detection] interface, under which the output status of electromagnet and air valve can be detected:

- (01) dial the line
- (02) air shear line
- (03) electric wire cutting
- (04) frame pressing
- (05) medium pressure foot
- (06) loose thread
- (07) supporting foot presser
- (08) air valve output 1

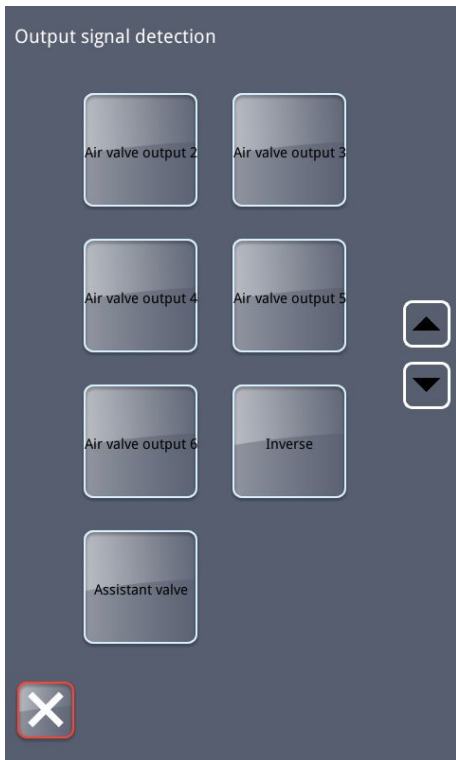

- (09) air valve output 2
- (10) air valve output 3
- (11) air valve output 4
- (12) air valve output 5
- (13) air valve output 6
- (14) flip the foot
- (15) auxiliary air valve

2.2.3 Spindle motor correction

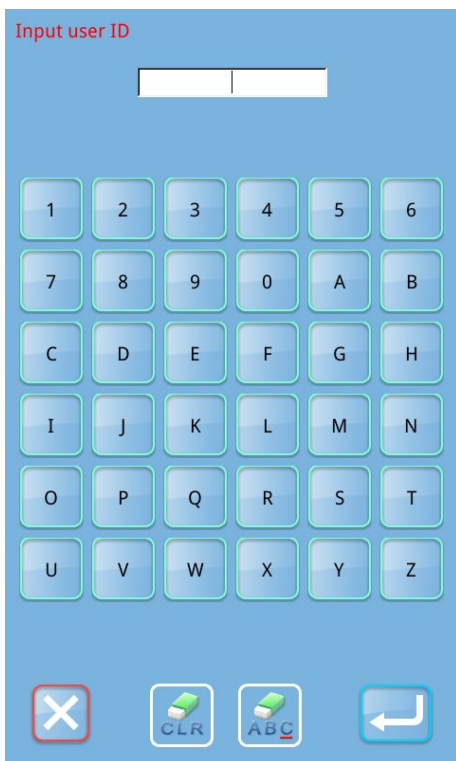

Click "spindle motor correction" on the interface of "test", and the system will prompt you to enter the password. If the password is entered correctly, you can enter the interface of "spindle Angle installation test".

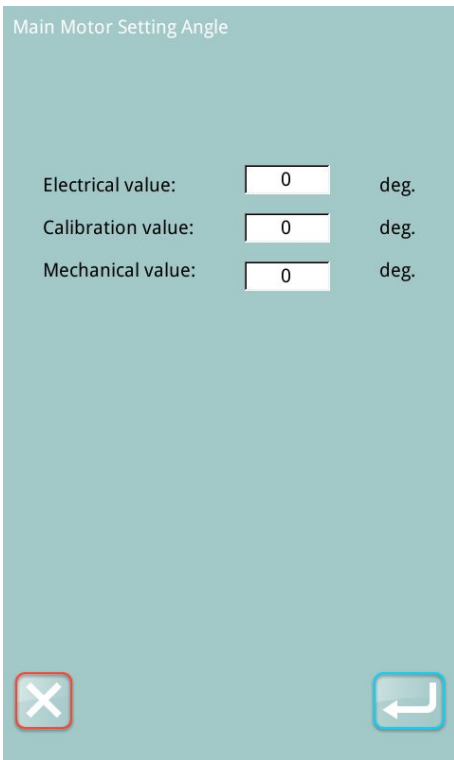

Under the interface of spindle Angle installation and test, remove the spindle motor, rotate the hand wheel to swing the needle rod to the highest point, reinstall the spindle motor, confirm that the electrical value displayed is within 0-30 ° or 330-360 °, and then



press ok . Otherwise, remove the spindle and repeat the above operation.

2.2.4 Speed test

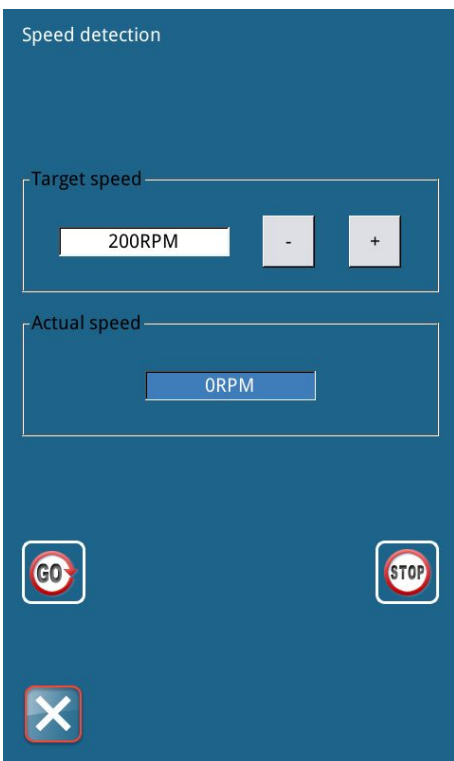

In the [detection] interface, click "speed test" to enter the [speed test] interface.

③ Display the current spindle motor "target speed" and "actual speed".

② The spindle motor speed can be set by clicking "speed

minus" and "speed plus". After clicking "start"



, the spindle motor will run at the set speed. At this point, the actual measured speed will be displayed in the "actual speed" column.



Click stop , and the machine stops running.



Click exit to return to the previous interface.

2.2.5 XY motor origin detection

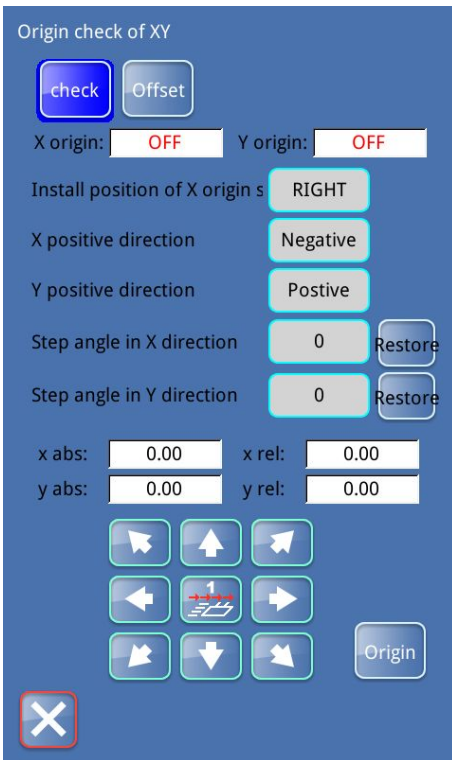

In the "detection" interface, click "XY motor origin detection"



to enter the "XY origin detection" interface and display

the sensor status and coordinate information:

- ① X origin: display the current ON/OFF state of X origin sensor according to the state of X origin sensor.
- ② Y origin: according to the state of the Y origin sensor, display the current state of the Y origin sensor ON/OFF.
- ③ X absolute coordinates: display X absolute coordinates, the value will change according to the motor movement
- ④ X relative coordinates: display X relative coordinate value, the value will change according to the motor movement
- ⑤ Y absolute coordinates: display Y absolute coordinates, the value will change according to the motor movement
- ⑥ Y relative coordinates: display Y relative coordinate value, the value will change according to the motor movement
- ⑦ drive motor direction keys: drive motor movement, the top will follow the absolute value of X/Y and X/Y relative value
- ⑧ Back to the origin

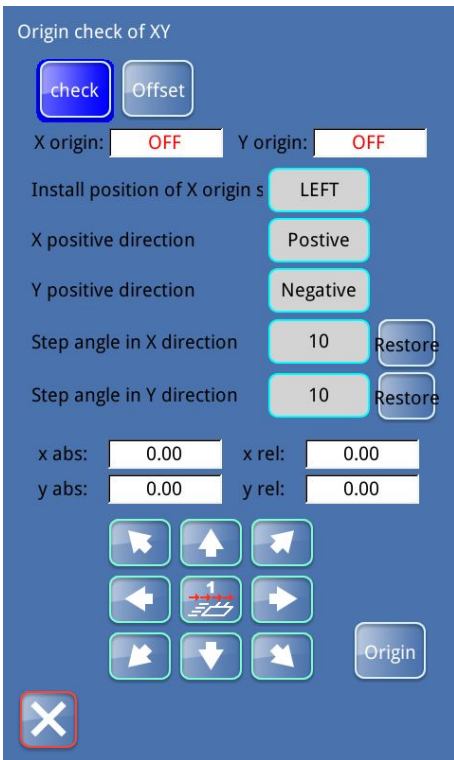



Under the "XY origin detection" interface, the "detection" and "deviation" interfaces can be selected.

The default interface of the system is the [detection] interface, and the "detection" icon in the interface is shown in blue



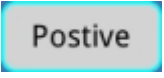

, with the following contents:

⑨ Installation position of X origin sensor: click "right"  or "left"  to switch installation position of X origin sensor.

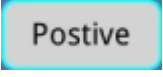
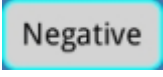
⑩ X positive direction: click the right "negative"  or "positive"  to switch the direction of X positive direction.

⑪ Y positive direction: click the right "positive"  or "negative"  to switch the direction of Y positive direction.

⑫ X step Angle fine-tuning: display the current X step Angle fine-tuning value. Click the value  on the right side to enter the parameter setting interface of U40 X step Angle fine-tuning:



Enter the value through the number key below the interface, click "confirm"  to confirm the value, and return to the "XY

origin detection" interface, click "back"  to cancel the operation, and return to the "XY origin detection" interface.

In the interface of "XY origin detection", click "restore"  on the right side of X step Angle fine-tuning to restore the value.

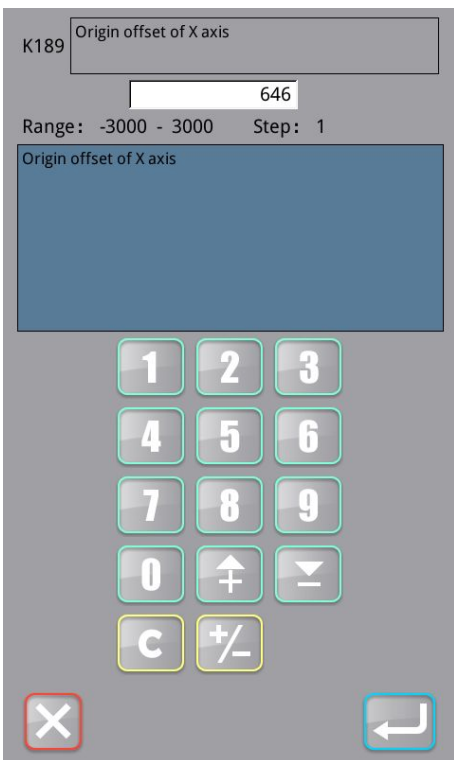
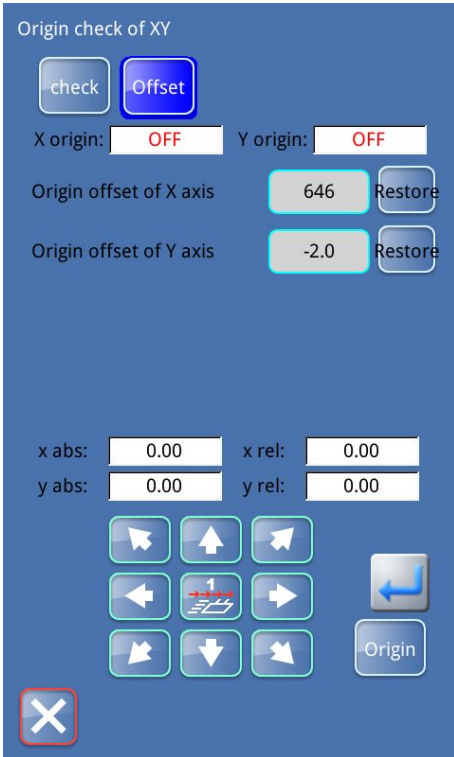
⑬ Y step away from the Angle of fine-tuning: show the current step Y values from the Angle of fine-tuning, but by clicking the right number , enter the interval Angle fine-tuning U41 Y parameter Settings interface, parameter setting method and interval Angle of fine-tuning 【⑫ X step Angle fine-tuning.】





In the "XY origin detection" interface, click "offset"  to enter the "offset" interface. The "offset" icon on the interface shows blue color  , and the X-axis origin offset and Y-axis origin offset are displayed on the interface.

The absolute value of X/Y and relative value of X/Y will be displayed along with the movement at the top. After the

movement is completed, click "confirm"  and the origin deviation of X/Y axis will be displayed at the value on the right side of the origin deviation of X axis and the value on the right side of the origin deviation of Y axis.

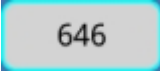
① X-axis origin offset: display the current X-axis origin offset.

Click the value  on the right side to enter the parameter setting interface of [K189 X-axis origin offset] : Enter the value through the number key below the interface, click

"confirm"  to confirm the value, and return to the "XY

origin detection" interface, click "back"  to cancel the operation, and return to the "XY origin detection" interface.

In the "XY origin detection" interface, click "restore"  to the right of the origin deviation of the X-axis to restore the value.

② Y-axis origin deviation: display the current Y-axis origin deviation value. Click the value  on the right side to enter the parameter setting interface of [K01 Y-axis origin deviation]. The parameter setting method is the same as ① X-axis origin deviation.

2.2.6 Origin detection of middle pressure foot

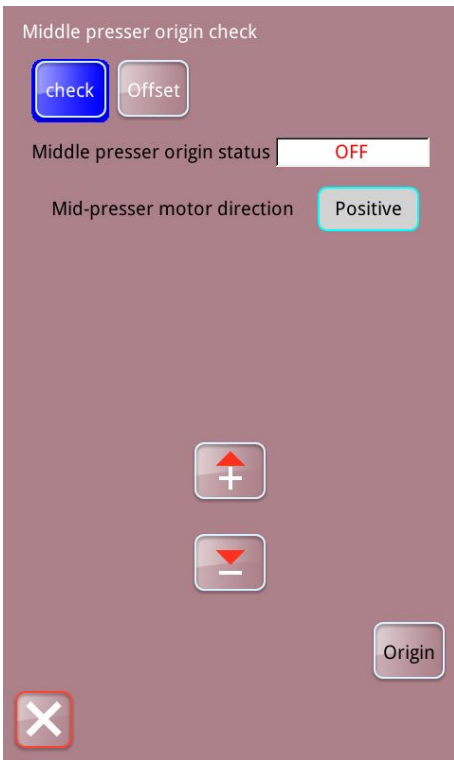



In the [detection] interface, click "middle pressure foot origin

detection"  to enter the [middle pressure foot origin detection] interface.

Under the interface of "origin detection of middle pressure foot", the interface of "detection" and "position" can be selected.

The default interface of the system is the [detection] interface, and the "detection" icon in the interface is shown in blue

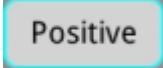
, with the following contents:

- ① medium pressure foot origin state: according to the original state of medium pressure foot, display the current ON/OFF state of medium pressure foot origin sensor
- ② medium pressure foot motor steering: click the right side of the "positive"  or "reverse" , can switch medium pressure foot motor steering.

- ③ click "move up" , medium pressure foot move up

- ④ click "move down" , the foot of the medium pressure move

Click "origin" and return to the origin

- ⑤ Click "origin"  and return to the origin

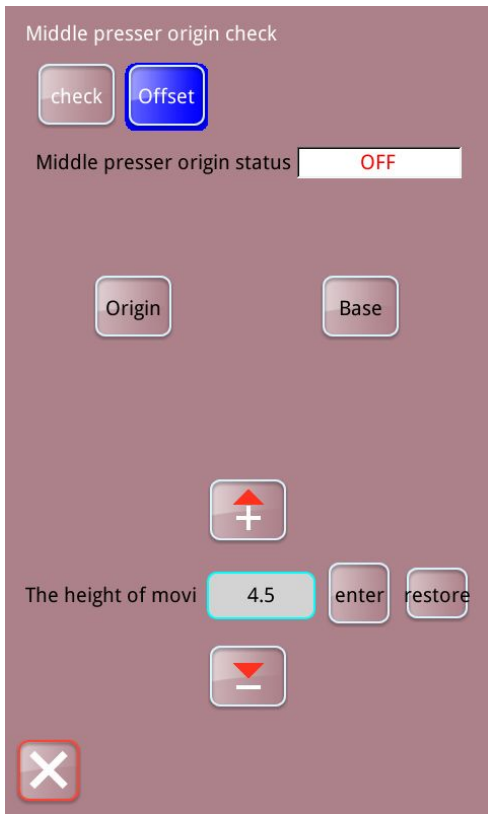

Under the interface of "middle pressure foot origin detection",

click "position"  to enter the interface of "position".

After entering the interface, the icon is shown as blue .

The interface display is as follows:

① Origin state of medium pressure foot: according to origin state of medium pressure foot, the current ON/OFF state of origin sensor of medium pressure foot is displayed

② Click "origin"  to return to origin

③ Click base point  and descend to base point

④ Medium pressure foot servo height: show the current medium

pressure foot height of follow-up, click the "up" , can increase the medium pressure foot servo height values, click the

"down" , can reduce the medium pressure foot servo

height value, set up is completed, click the "ok"  to determine the medium pressure foot height of follow-up, click the

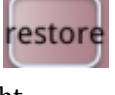
"restore" , restore the default medium pressure foot servo height.

2.2.7 Shear line motor detection

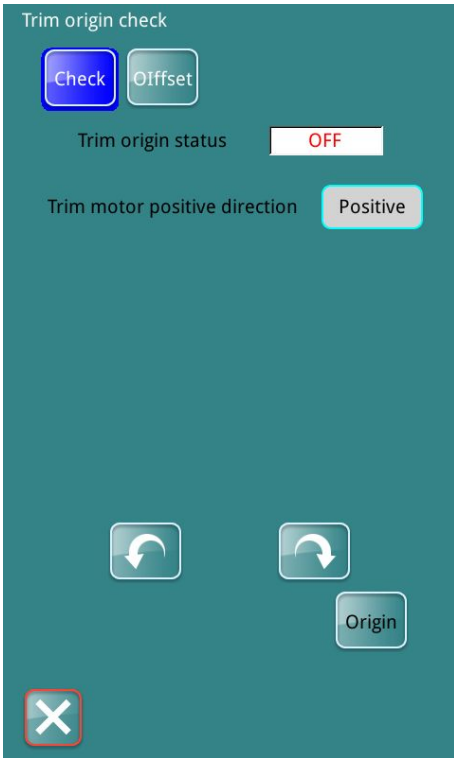

In the interface of "detection", click "detection of wire cutting motor"  to enter the interface of "detection of wire cutting motor".

Under the interface of "detection of wire cutting motor", the interface of "detection" and "position" can be selected.



The default interface of the system is the [detection] interface, and the "detection" icon in the interface is shown in blue

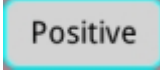
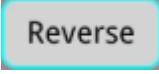

, with the following contents:

- ① Origin status of shear line: display the current ON/OFF status of the origin sensor of shear line according to the origin status of shear line
- ② Positive direction of wire cutting motor: click "forward"  or "reverse"  on the right side to switch the positive direction of wire cutting motor.

- ③ Click "reverse" , motor reverse, click "positive turn"

- , motor positive turn, click "origin" , motor back to the origin.

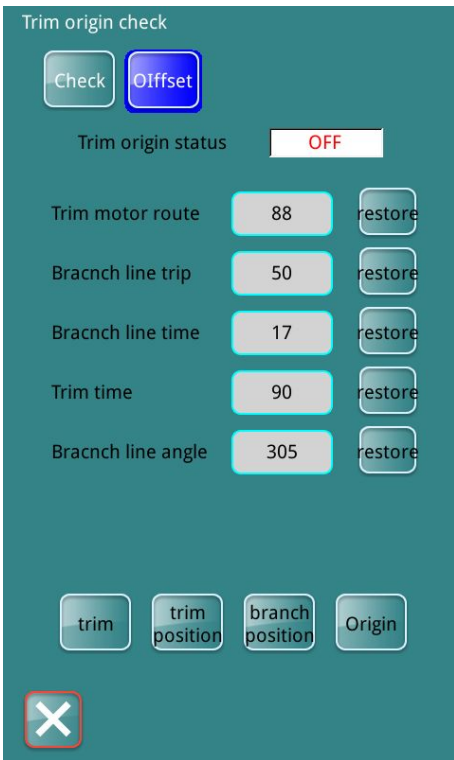

Under the interface of "detection of wire cutting motor", click "position" to enter the interface of "position". At this time, the



icon of "position" is displayed in blue, and the display content is as follows:

① Origin status of shear line: display the current ON/OFF status of the origin sensor of shear line according to the origin status of shear line



②: Click "test trim thread", the motor performs a trim thread action



③: Click "trim thread position", and the trim thread motor will rotate to the trim thread position (return knife position).



④: After clicking "parting position", the cutting motor will rotate to the parting position (cutter out position).





⑤: After clicking "origin", the wire cutting motor will return to the initial position (after the above operation of wire cutting position dividing position, press the function key to return to the initial position).



② Stroke of cutting line motor: display the current stroke value of cutting line motor. Click the value **88** on the right side to enter the parameter setting interface of [stroke of U19 cutting line motor] :

Enter the value through the number key below the interface, click "confirm"  to confirm the value, and return to the interface of "detection of wire cutting motor", click "return"

 to cancel the operation, and return to the interface of "detection of wire cutting motor".

In the interface of "detection of shear line motor", click "restore"  on the right side of the stroke of the shear line motor to restore the value.

③ Dividing line stroke: display the current dividing line stroke value. Click the value **50** on the right side to enter the parameter setting interface of [U20 dividing line stroke]. The parameter setting method is the same as [② cutting line motor stroke].

④ Line breaking time: display the current line breaking time value. Click the value **17** on the right side to enter the parameter setting interface of U21 line breaking time. The parameter setting method is the same as [② cutting line motor stroke].

⑤ Line cutting time: display the current line cutting time value. Click the value **90** on the right side to enter the parameter setting interface of [U22 line cutting time]. The parameter setting method is the same as [② cutting line motor stroke].

⑥ Dividing line Angle: display the current dividing line Angle value. Click the value **305** on the right side to enter the parameter setting interface of [U23 dividing line Angle]. The parameter setting method is the same as [② cutting line motor stroke]

2.2.8 Continuous operation

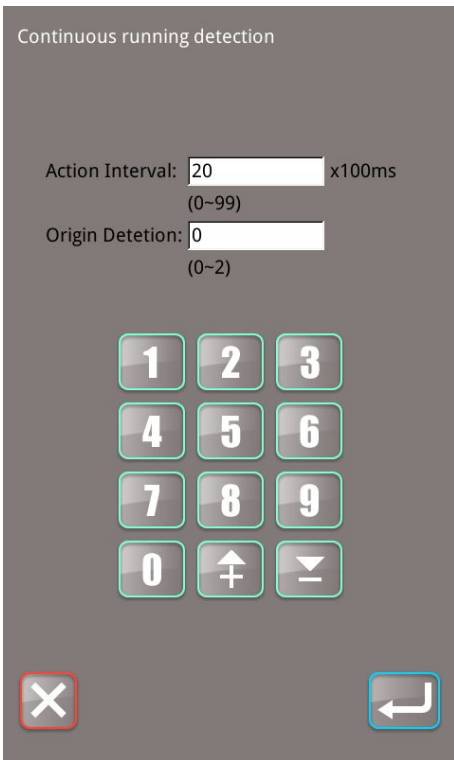

In the [detection] interface, click "continuous operation" to enter the [continuous operation test] interface, which displays the following contents:

① Action interval: display the current action interval value, unit: ×100ms, range of interval value (0~99), use the number key



below the interface to enter the value, click "confirm" to confirm the value, and return to the [detection] interface, click



"return" to cancel the operation, and return to the [detection] interface.

② Stitch origin detection: display the current stitch origin detection value (range (0~2)). Use the number key below the





interface to enter the value, click "confirm" to confirm the value, and return to the [detection] interface. Click "return"



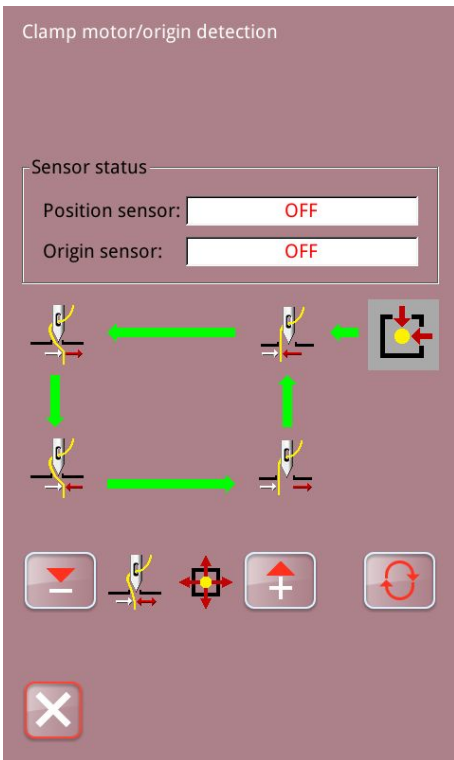

to cancel the operation and return to the [detection] interface.

2.2.9 Catch wire motor detection



Click "cable motor detection"  on the interface of [detection] and enter the interface of [cable motor/origin sensor detection]. The interface displays as follows:

- ① Sensor state:
 Position sensor: according to the position state of the wire grasping mechanism, the ON/OFF state of the wire grasping position sensor is displayed.
 Origin sensor: display the ON/OFF status of the origin sensor of the grab line according to the status of the grab line origin sensor.

- ② Click  or  and the grab motor will move in one step. Click  to switch different positions of the wire grab motor, and the figure of the position displayed is shadow.

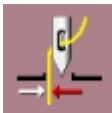
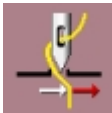
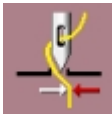
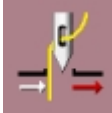
-  : Standby position (front)
-  : Line bending position
-  : Clamp wire position
-  : Retreat position (inside)

After the detection is completed, click "exit"  to exit the interface of wire grasping motor/origin sensor detection.

Start SW to search the origin of the grasping motor.
 Note: starting switch is used to retrieve the origin of the grasping motor, and it becomes effective



2.2.10 RFID setting

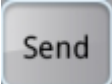

In the [detection] interface, click "RFID setting"  to enter the [RFID setting] interface, and the interface displays the current pattern number and range (1~999). You can use the number key at the bottom of the interface to enter the pattern number, click

"send"  to write the current pattern number into the

RF card, and click "read"  to read the pattern number

in the RF card. Click ok  or return  to return to the detection interface.

2.2.11 Extended function detection

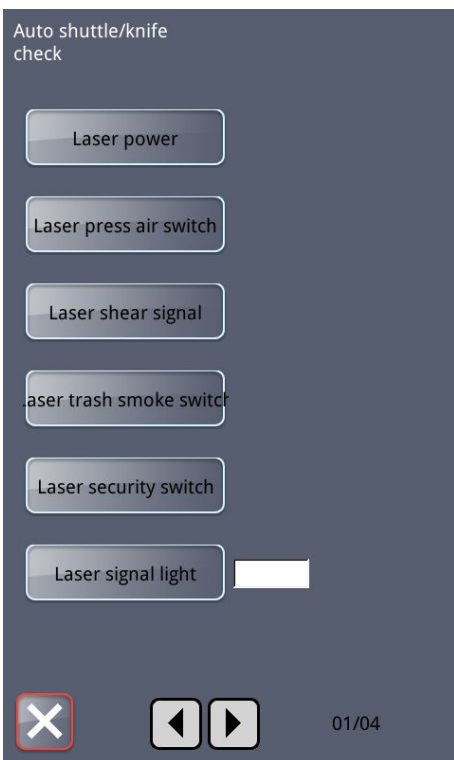

In the interface of "detection", click "extension function

detection"  to enter the interface of "automatic shuttle changing/cutter detection" to detect the input/output signals of each extension function:

- ① laser power supply
- ② laser pressure valve
- ③ laser cutting signal
- ④ laser waste gas valve
- ⑤ laser safety switch
- ⑥ laser indicator



- ⑦ shuttle changing motor
- ⑧ grab arm cylinder
- ⑨ clamping cylinder
- ⑩ Attend grasp arm cylinder
- ⑪ in core signal
- ⑫ shuttle changing step test
- ⑬ shuttle changing movement

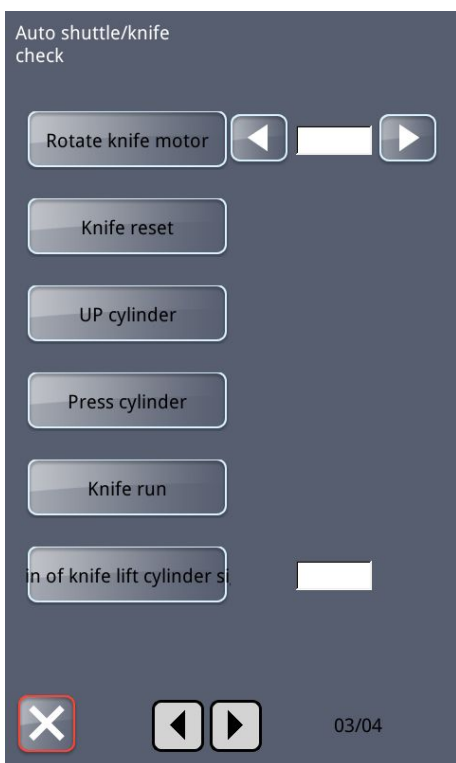

- ⑭ rotary cutter machine
- ⑮ rotating knife reset
- ⑯ boost cylinder
- ⑰ cylinder pressure
- ⑱ Start cutter
- ⑲ knife cylinder origin signal to ascend

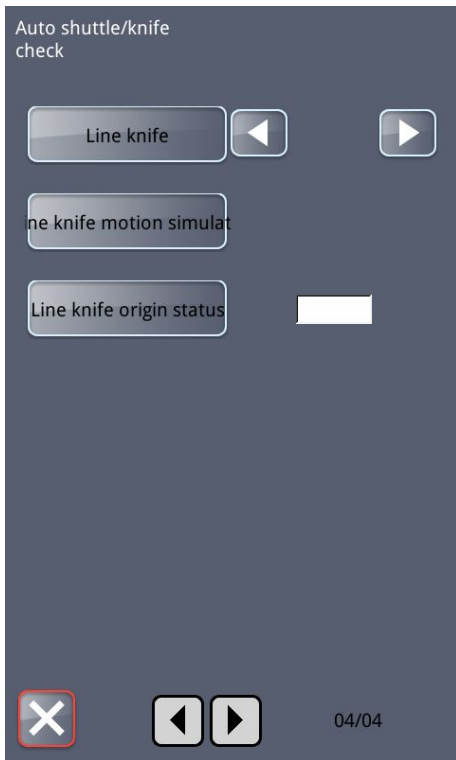

- ⑳ straight knife
- ㉑ Simulation of linear cutter action
- ㉒ State of linear cutter origin sensor

2.2.12 Multi-function IO detection

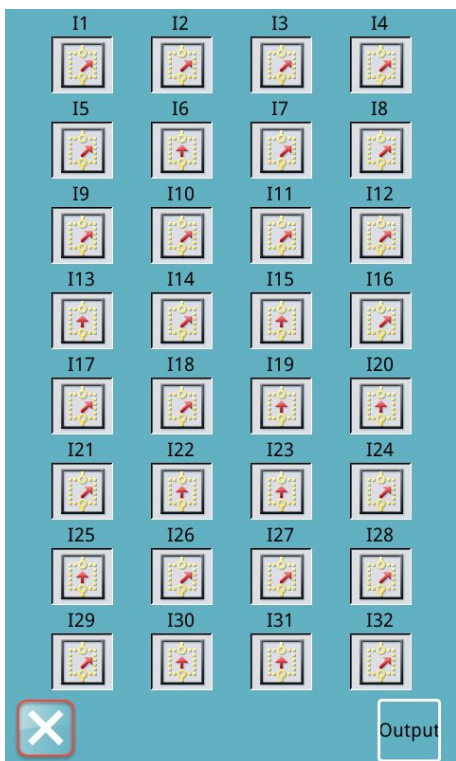

In the "detection" interface, click "multifunction IO detection"



to enter the "multifunction IO detection" interface.

In the interface of "multi-function IO detection", you can select the interface of "Output" and "Input".

The default interface of the system is the [Output] interface, under which the status of Input signal can be detected. Click

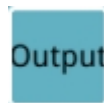

"Output" to enter the [Input] interface.

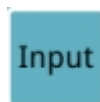

Click "Input" to switch to the [Output] interface.



In the [Input] interface, the status of the output signal can be detected.

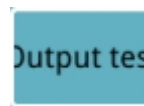
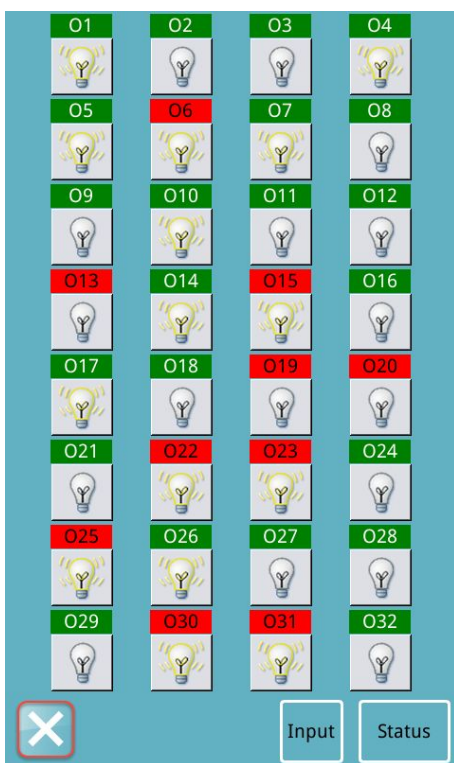

Click output test  to test the input signal.

2.2.13 Touch screen correction

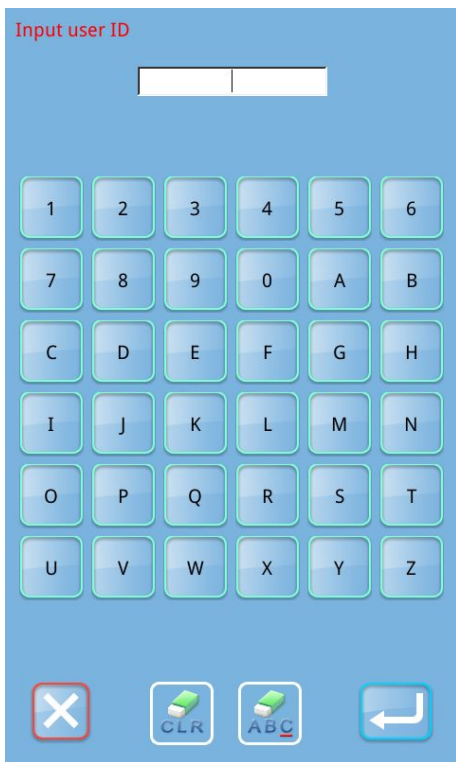



In the [detection] interface, click "touch screen correction"

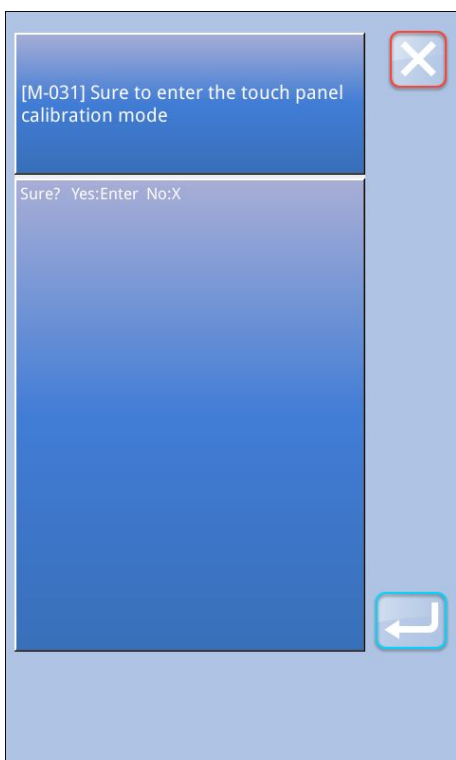

and the system will prompt for entering the password. If the password is entered correctly, the system will continue to prompt [m-031] to enter the touch screen correction mode?





Prompt [[m-031] confirm entering touch screen correction mode?] Interface. Click "yes"  to enter the interface of

touch screen correction. Click "no"  to exit touch screen correction.

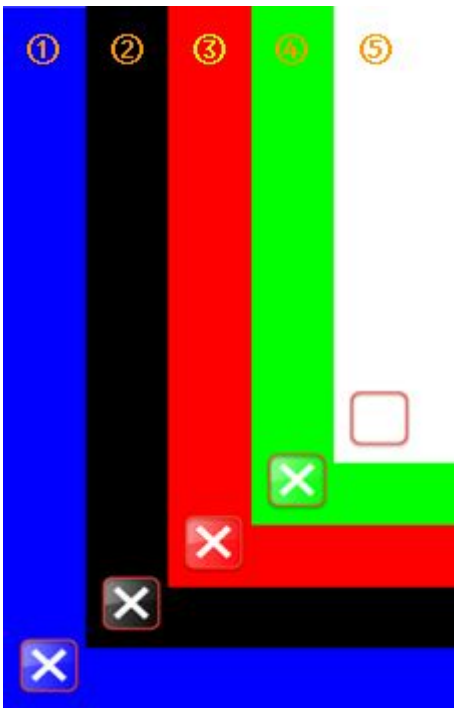
2.2.14 LCD test



In the [detection] interface, click "LCD detection"  to enter the [LCD detection] interface. After entering the screen, it will display blue. Click the screen and the color will be blue → black → red → green → white → blue..... Loop switch color, click

"exit" , return to the [detection] interface.







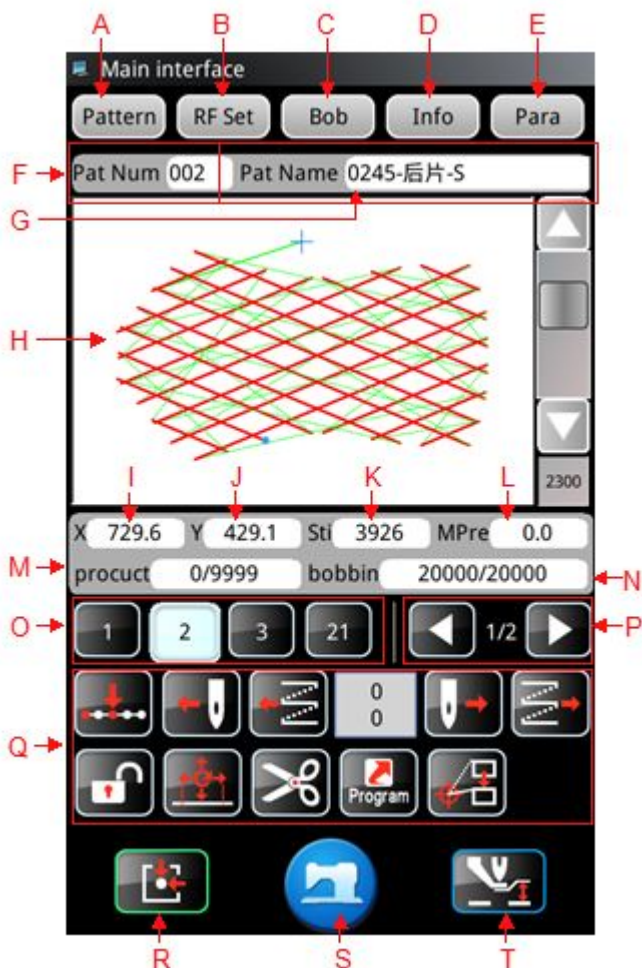

3 Pattern sewing interface



In the "pattern selection" interface, click  to enter the sewing interface to set pattern sewing parameters.



No.	Function	description
A	Design management	Enter the interface of pattern management
B	The RF registration	The current pattern can be written to the RF card
C	Winding.	Enter winding mode
D	information	You can view the action header statistics class information
E	Set up the	User parameters can be set
F	Figure no.	Displays the current pattern number
G	Pattern name	Displays the current pattern name
H	Pattern preview area	Click the pattern preview area to view basic pattern information and preview patterns

I	X-direction range	Displays the current pattern X direction range
J	Y-direction range	Displays the current pattern Y direction range
K	Pin number	Displays the current pattern drop pin value
L	Middle pressure foot height	Displays the height of the current pattern middle pressure foot
M	Production count	Displays the current/set value of the production counter
N	The bottom line count	Displays the bottom line count
O	Shortcut pattern list	Displays a list of all saved patterns
P	Turn the page	Page-turning shortcut pattern list
Q	Function parameters edit key	<p>: Press the button to enter the jump interface, enter the number of jump pins/segment, press "confirm" , and the template can be moved to the position of the number of pins/segment.</p> <p>: Lock the current edit pattern to prevent the current pattern from being switched, only automatic switch pattern, not manual switch pattern</p> <p>: Manual switch pattern, not automatic switch pattern.</p> <p>: A paragraph in the pattern can be modified</p> <p>: Perform a line cut</p> <p>: You can enter the [quick parameter] setting interface</p> <p>: Move up seam position</p>
R	reset	Back to the origin
S	Switch to the pattern selection interface	Switch to the pattern selection interface
T	Medium pressure foot	Function setting of middle pressure foot

3.1 Medium pressure foot function

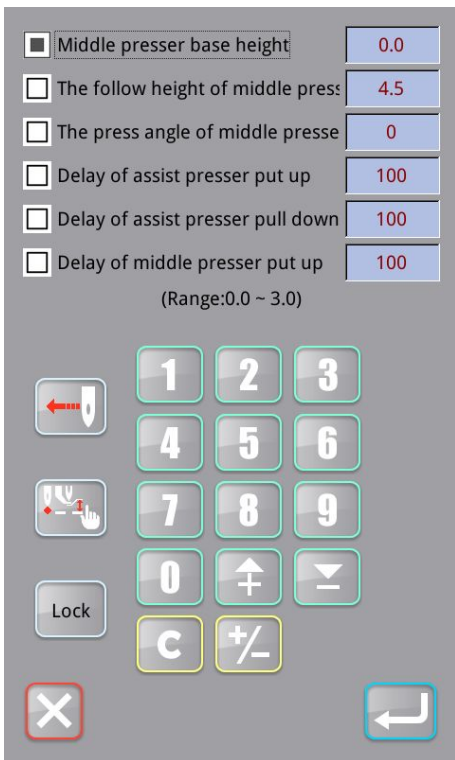



In the interface of "pattern sewing", click "medium pressure foot"



to enter the interface of "medium pressure foot setting", and the following parameters can be set:

- ② Medium pressure foot: basic value can be set up medium pressure feet start points, click on the "benchmark" middle presser avoiding, selected on the left shows , parameters are selected, will display the current parameters, the range will be automatically updated according to the selected parameters, parameter values can be below the number keys

to modify, modify finished, click the "ok"  to confirm the changes and return pattern sewing **】**

【 interface, click the "cancel"  to cancel the operation and return pattern sewing **】** **【** interface.

- ② Follow height of medium pressure foot: the follow height of medium pressure foot can be set. The operation method is the same as "① reference value of medium pressure foot".
- ③ Medium pressure foot press Angle setting: medium pressure foot press Angle value can be set. The operation method is the same as "① reference value of medium pressure foot".
- ④ Delay of auxiliary presser foot lifting: delay value of auxiliary presser foot lifting can be set. The operation method is the same as "① reference value of medium pressure foot".
- ⑤ Delay of auxiliary foot drop: delay value of auxiliary foot drop can be set. The operation method is the same as "① reference value of medium pressure foot".
- ⑥ Delay of medium pressure foot lifting: delay value of medium pressure foot lifting can be set. The operation method is the same as "① reference value of medium pressure foot".

- ⑦ : Drop back after the break

Note: this function is only valid when the parameter u14-21 is broken and the parameter value is set to 1 or 2. The number of retractable stitches is available in parameters u14-22Set the

number of retractable stitches after broken wire.

⑧ Lock: lock the current edit state. After the lock, the parameter modification is invalid. When modifying the parameter, the state must be switched to unlock.



: Middle pressure foot parameters can be modified.

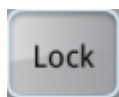

: Modified middle pressure foot parameter is invalid

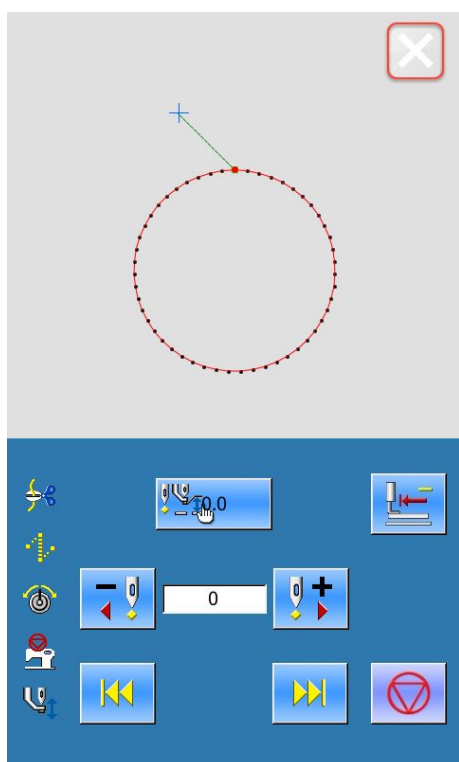

⑨: Set the height of single pin middle pressure foot



Click "set height of medium pressure foot of single pin" to enter the interface of "set height of medium pressure foot of

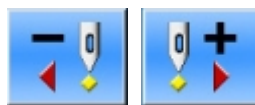

single pin". Click to select the position where the height of medium pressure foot should be set.

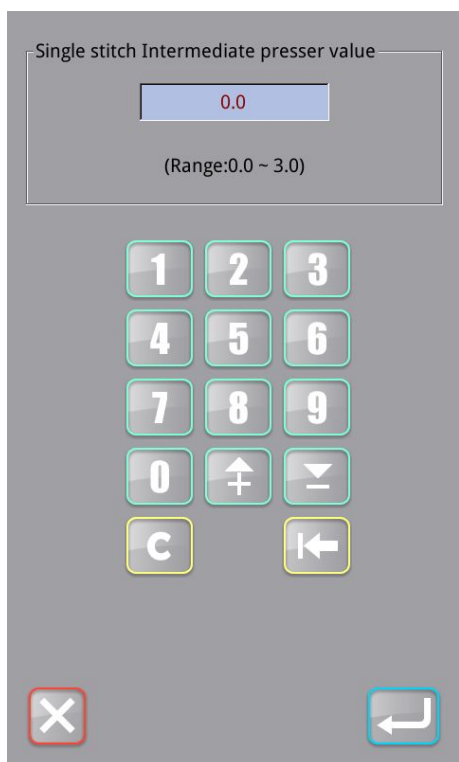

Click "setting of single pin medium pressure foot"



to enter the interface of "setting of single pin medium pressure foot" and change the height of medium pressure foot. Click "save" and click "close" after saving successfully to return to the interface of "setting of medium pressure foot".

3.2 Modify the seam

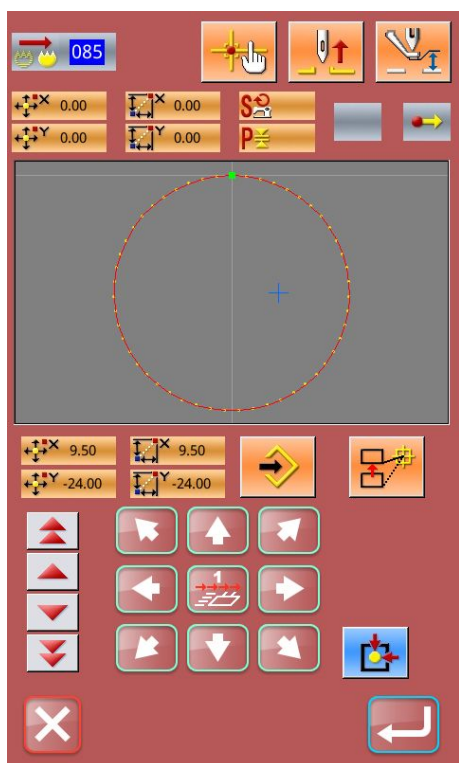

If the imported pattern position is different from the template, the user can modify the seam point as needed.

In the interface of "pattern sewing", click "modify sewing point"



to enter the interface of "modify sewing point", as shown in the figure.



Press the move key to move the seam starting point to the specified position

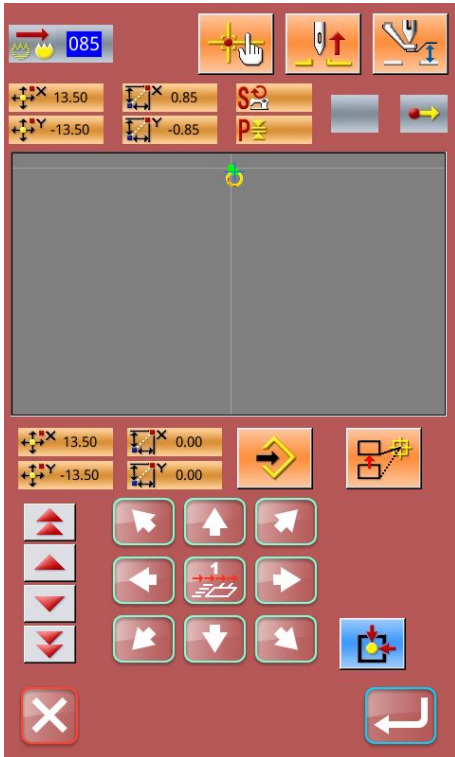

Press the "save" button  to complete the operation and move the seam starting point to the specified position.

The seam test button can be used to confirm whether the position of the seam starting point after last modification is accurate:

The previous paragraph, click, jump to the current position of the previous paragraph;

The previous stitch, click, jump to the current position of the previous stitch;

Next stitch, click, jump to the current position of the next stitch;

Next paragraph, click, jump to the current position of the next paragraph.

Try sewing to any point in the pattern can continue to move the pattern position based on this needle. After the setting is

completed, click "save"  to complete the operation and

move the sewing point to the specified position. Click exit  to return to the pattern sewing interface.

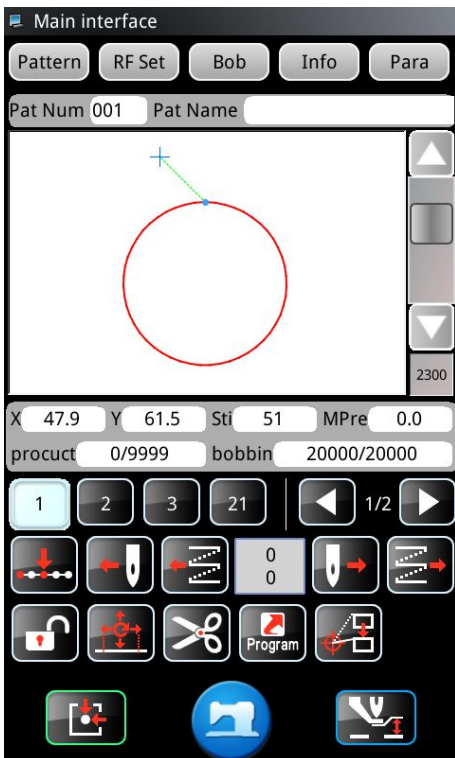



Click exit  to return to the pattern sewing interface.

4 Design management

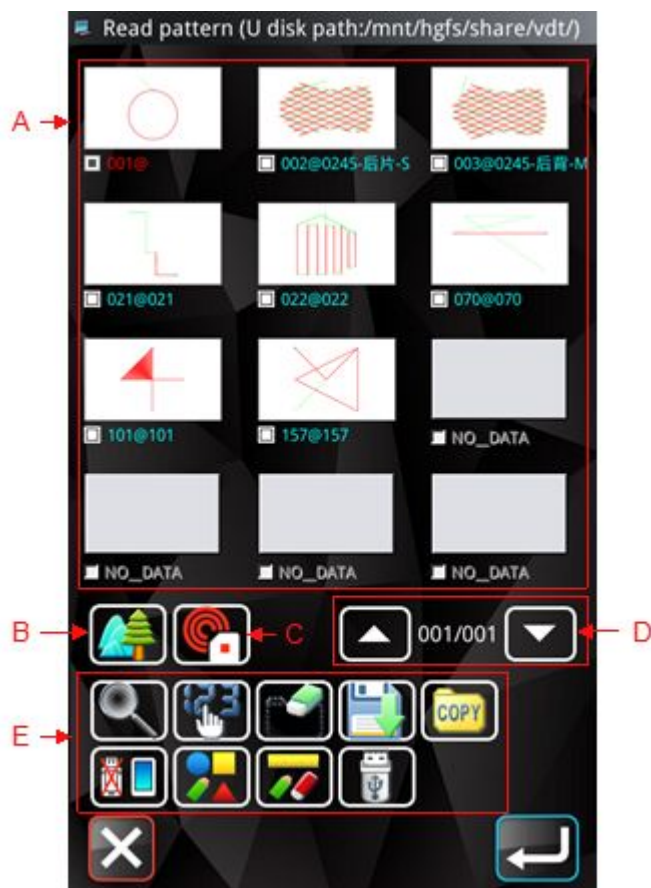
In the "pattern sewing" or "pattern selection" interface, click "pattern management"  to enter the "read pattern" interface.







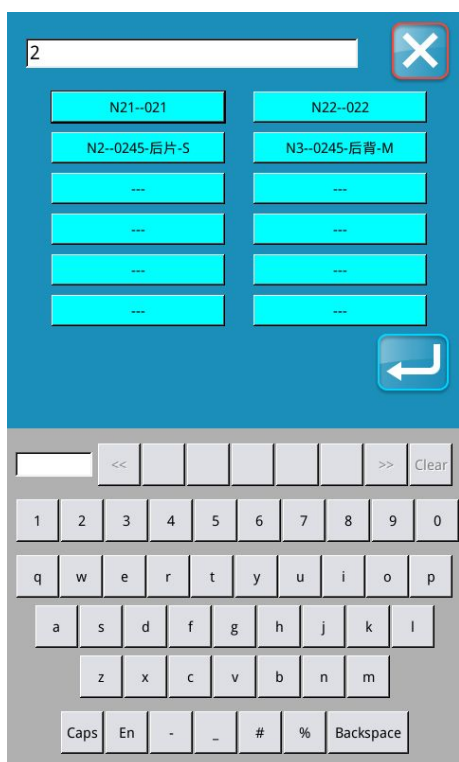

No.	Function	description
A	Figure list	The saved pattern displays the pattern, number, and name. Click the pattern or pattern name to select the pattern
B	Pattern preview	Click to preview the pattern, see [2.1 pattern preview]
C	The RF	Click to output the selected pattern to the RFID memory card
D	The flip key	Can turn up and down page pattern list
E	The function keys	 : Search pattern  : Redisplay the pattern list in order of modification time or number size  : Delete the pattern

		 : Save the pattern as  : Multiple options are available  : U disk into the pattern  : Can edit new pattern, enter pattern edit interface  : Modifiable pattern
--	--	--

4.1 The function keys



In "reading pattern" interface, click the "search" , enter the interface, the pattern search  can through the keyboard input characters in pattern or design name search pattern, click the "switch" in both Chinese and English,   or to switch input in English or Chinese, after selected figure, click the , switch pattern success and return to the interface, read figure click "cancel" , without switching pattern and return to the interface read figure.

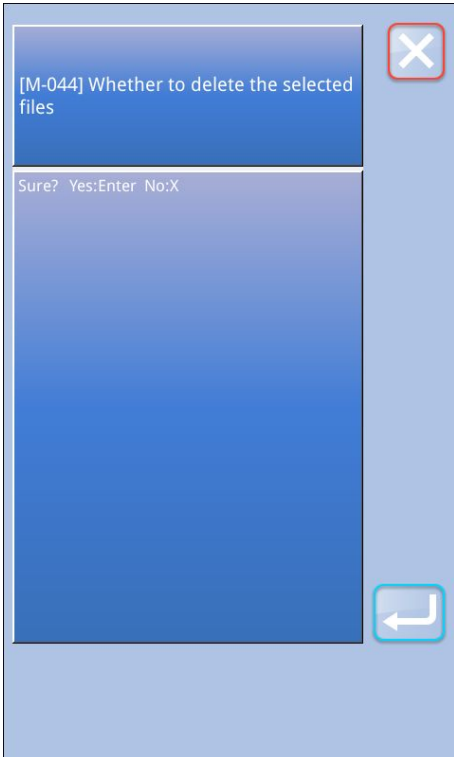

In the [read pattern] interface, select the pattern and click



"delete", the system will prompt [m-044] whether to

delete the selected file, click "ok" , delete the pattern and return to the [read pattern] interface, click "cancel"



,do not delete the pattern and return to the [read pattern] interface.

Note: the currently used pattern cannot be deleted.

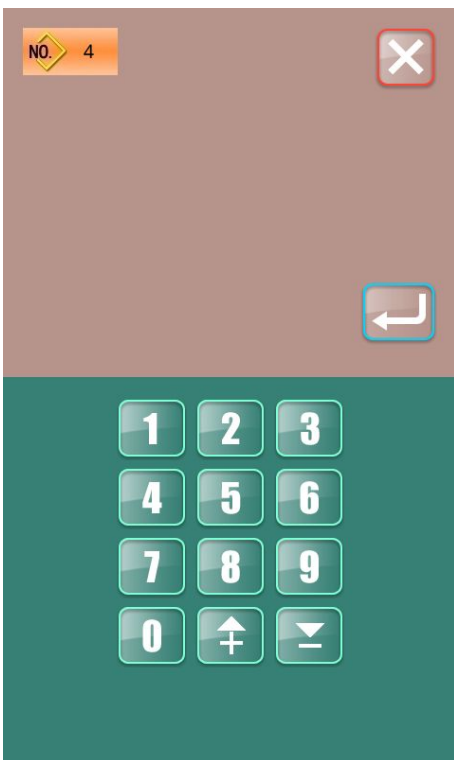

In the interface[read figure],after selected figure, click the



"save", then enter the figure save interface, through the digital key to enter the name of the save as figure below, click the





OK, figure save success and return to the interface,

read figure, click "cancel"  to cancel figure save and return to the interface read figure.

If the input pattern number has been occupied, the current

interface will display the pattern. After clicking "OK" , the system will prompt whether [m-039] overwrites the pattern.



Click "OK" , the pattern is saved successfully and returns

to the interface of [read pattern], and click "cancel"  to cancel the pattern and return to the interface of [read pattern].



In the interface of "read pattern", select the pattern and click "multi-select" . In the interface of "read pattern", the pattern can be multi-selected for batch operation.



In the "read pattern" interface, select the pattern and click "new" . The system will prompt [m-065] whether to edit the new pattern or not. Click "OK"  to enter the interface of "pattern editing" to edit the new pattern; click "cancel"  to enter the interface of "pattern editing" to edit the current pattern.

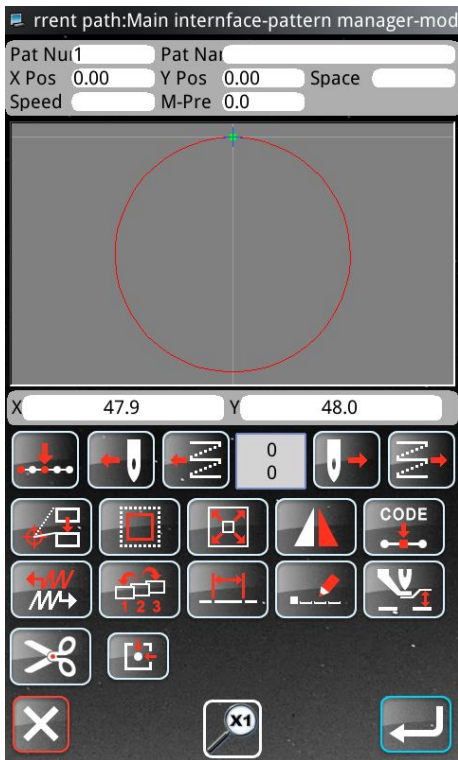

In the [read pattern] interface, select the pattern and click



"modify" to enter the [pattern modification] interface and modify the pattern.

5 Setting

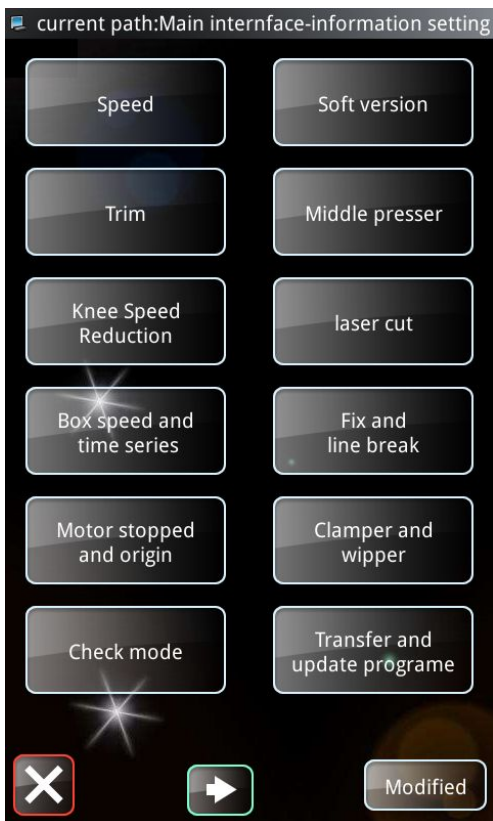

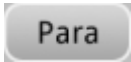
In the interface of "pattern selection" or "pattern sewing", press the "setup"  button to enter the interface of "setup".

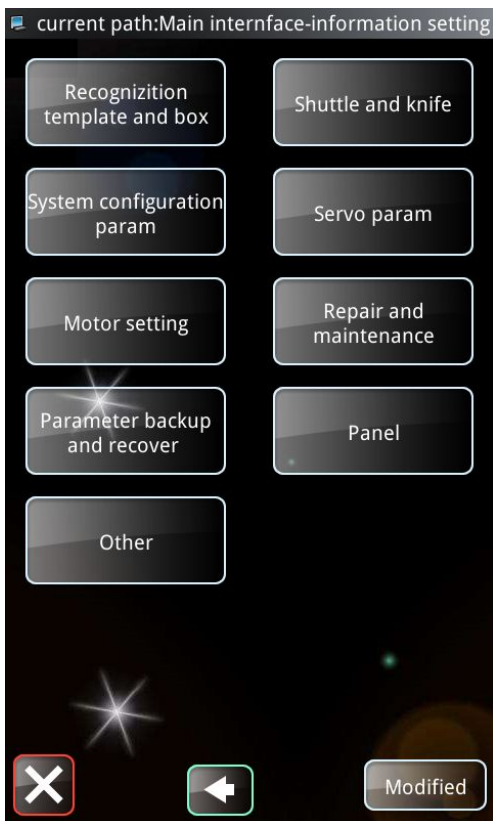

5.1 Version of the query

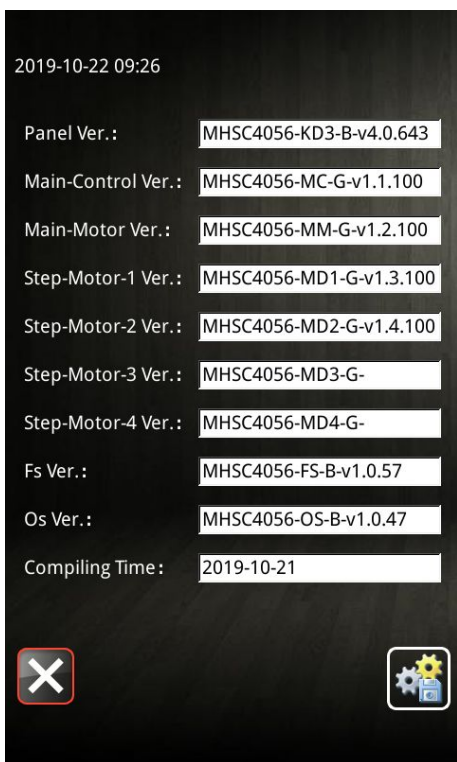

In the [setting] interface, click the "version query"

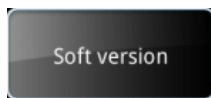

key to query the system software version.



: Save the current version information to the U disk root directory

5.2 Transmission and upgrade

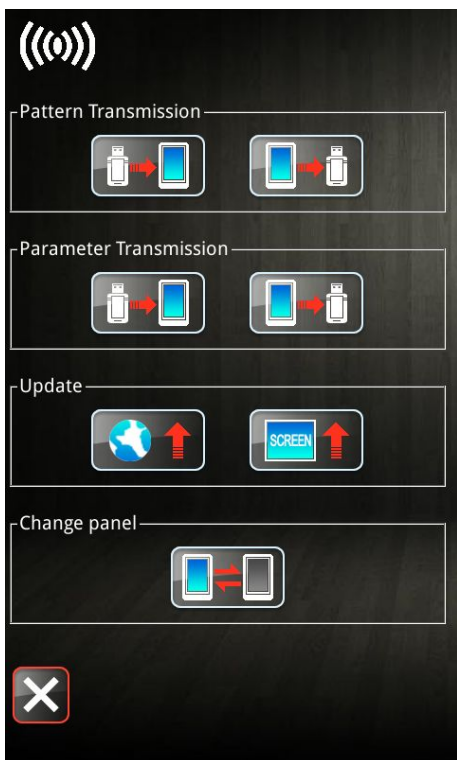

In the [setting] interface, click the "transmission and upgrade"

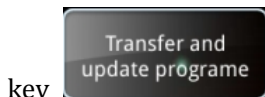

key to enter the [communication interface].

The functions that can be selected under this interface are divided into four categories:

- Synchronized transmission
- Parameters of the transmission
- Software upgrade
- replacement

Click the corresponding icon to carry out functional operations.



Click "cancel" to return to the [Settings] interface.

5.3 Servo parameters

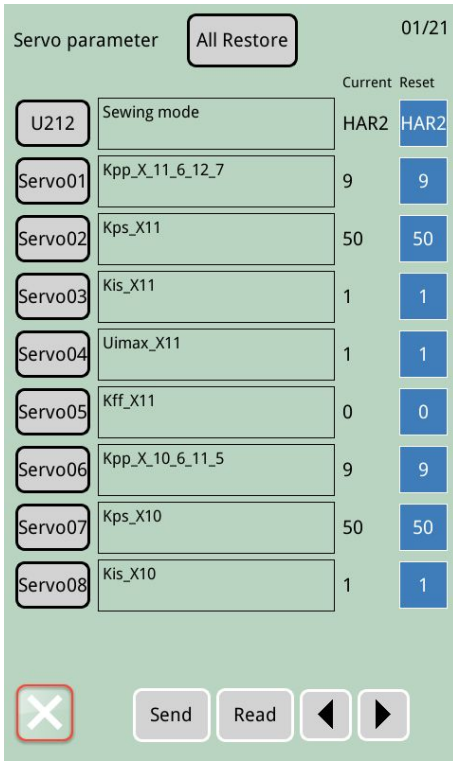

In the [setting] interface, click "servo parameters"



to enter the [servo special parameters]

interface.

Servo parameters are directly related to the sewing performance of the machine. Normally, the factory machine will store the default servo parameters. The servo parameters can only be modified when the sewing requirements change.

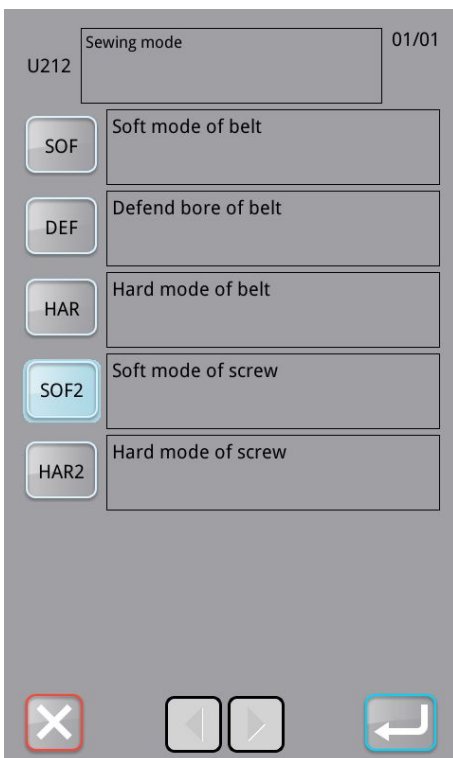

Example of SOF2 lead screw soft mode:

In the interface of "servo special parameters", click "U212" parameter key to enter the parameter setting interface of "U212 sewing mode" and select the sewing mode: SOF2 screw soft mode.



When selected, click "confirm" to enter sewing mode:



SOF2 screw soft mode. Click "cancel" to cancel the operation and return to the interface of [servo special parameters].

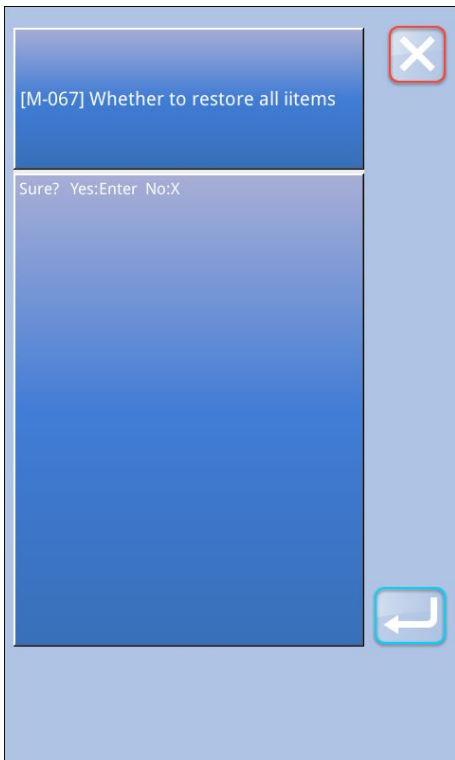

Enter sewing mode: after SOF2 screw soft mode, click "restore

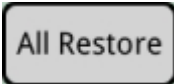

all"  , the system will prompt [m-067] whether to

restore all Settings, click "confirm"  , confirm to restore

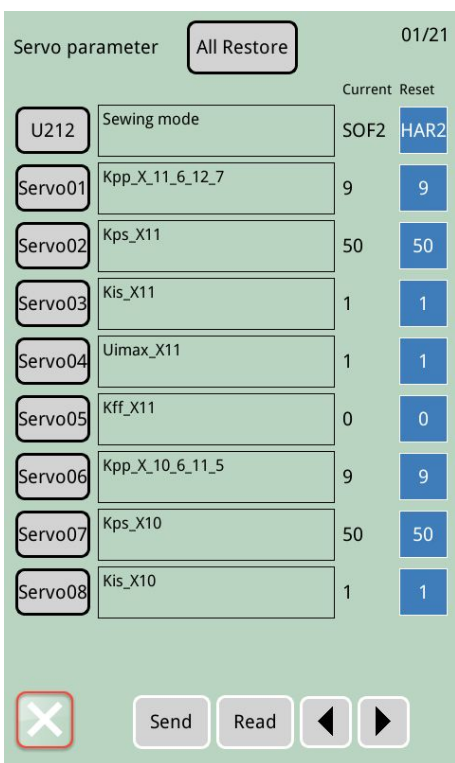
all Settings, click "cancel"  ,cancel the operation and return to the interface of [servo special parameters].

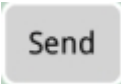

After confirming to restore all the Settings, click "send"

 and wait for about 1s, then click "read"  to

confirm whether the servo parameters have changed

5.4 Maintenance and maintenance Settings

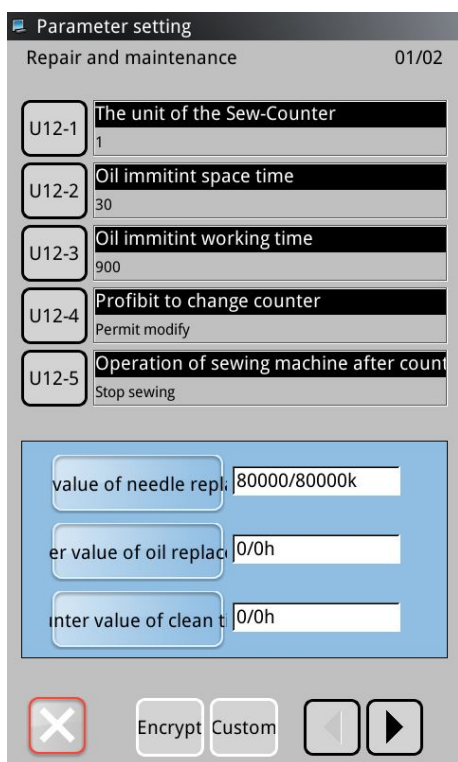

In the [setting] interface, click "maintenance and maintenance



setting" button to enter the [maintenance and maintenance setting] interface, U12 parameters can be set, or:

- 4)Change the needle count
- 5)Oil change count
- 6)Cleaning time count

5.5 Parameter backup and restore



In the [setting] interface, click "parameter backup and restore"

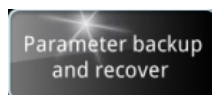

, the system will prompt for password input, password input success, will jump to the [parameter backup and restore] interface.

Click to select the parameters to be set, and operate through the button at the bottom of the interface:

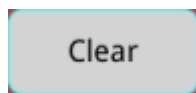

: After clicking, the parameters can be removed

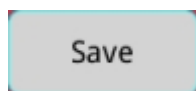

: Click to save the parameters

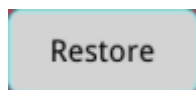

: After clicking, the parameters can be restored

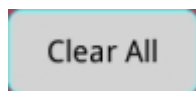

: Click to clear all parameters

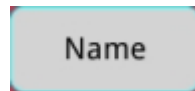

: After clicking, you can modify the name of the existing parameter

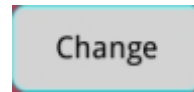

Click "switch parameters" to switch the interface of "parameter backup and restore" and "servo parameters backup and restore"



5.6 Panel Settings

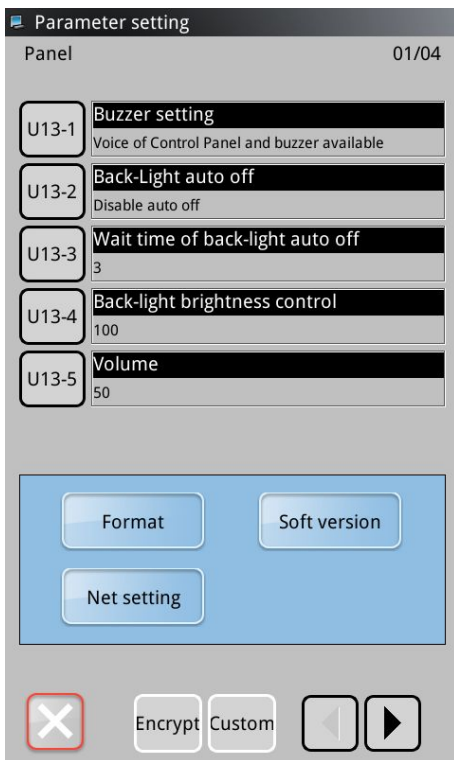

In the [Settings] interface, click the "panel Settings"



to enter the [panel Settings] interface to set

U13 parameters or:

- 4) formatting
- 5) Version of the query
- 6) Network Settings

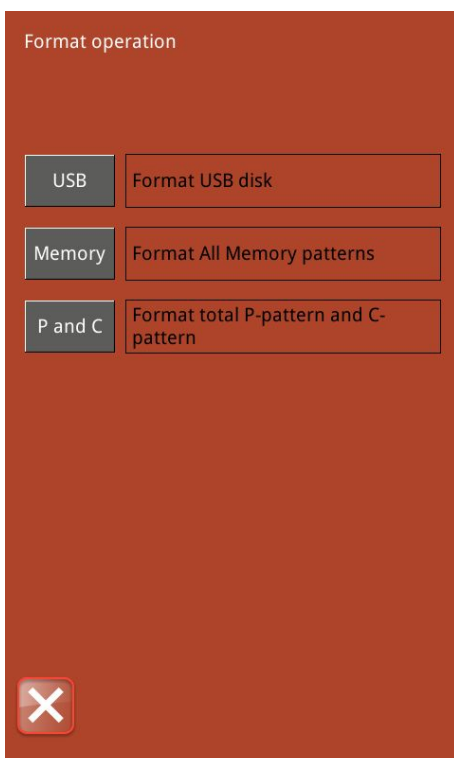

Click the "format" in the "panel Settings" interface to enter the "format operation" interface:



Click the "USB" to format the USB disk;

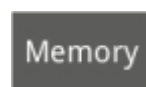

Click memory to delete all memory patterns;

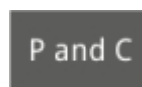

Click the "P and C" to delete all P and C patterns.

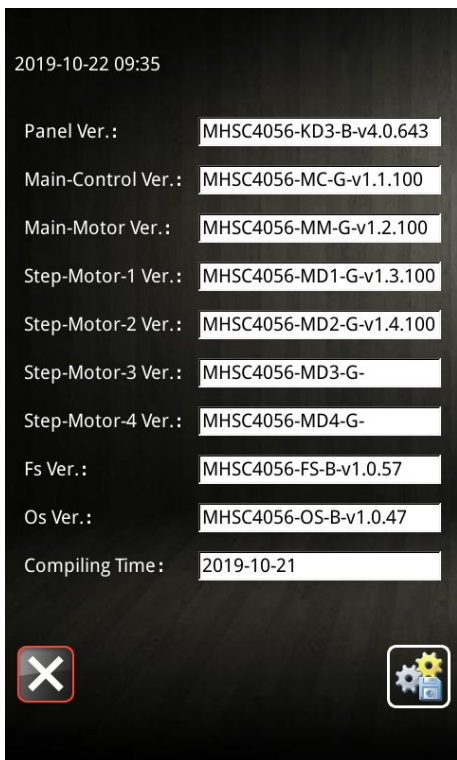

In the interface of "panel setting", click "version query"

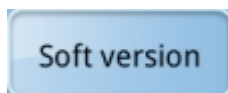

to enter the interface of "version query".



Click the "save" to save the current version information to the U disk root directory

5.7 U Parameter change method

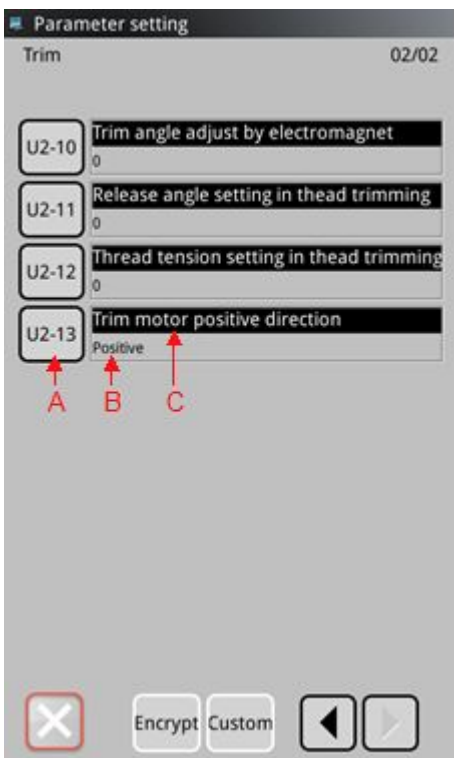

For example, select type parameter setting for reference, as follows:

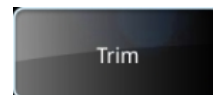



Press the button of "shear line setting" to enter the interface of [shear line setting], and find the parameter

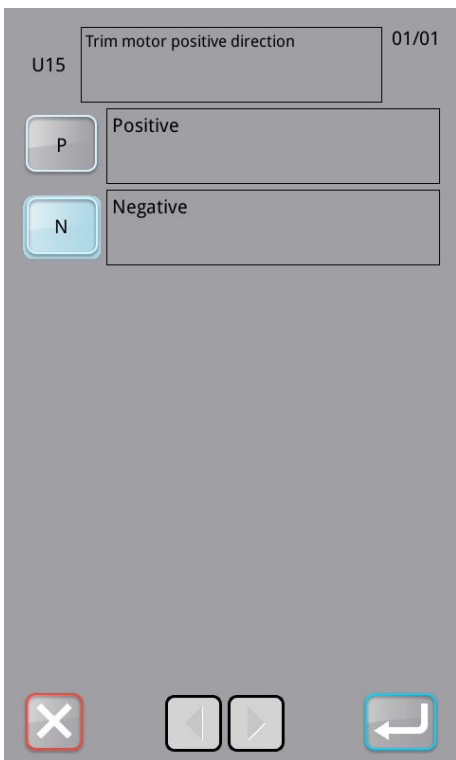

code A: u2-13 through the button of "next page" to set the parameters. At this time, C: [positive direction of shear line motor] state is B: [positive direction].



Press the button of "u2-13 parameters"  to enter the parameter setting interface of [positive direction of shear line motor], select the mode key 'N' reverse that you want to change,

and press the button of "confirm"  to complete the setting and change of the corresponding parameters.

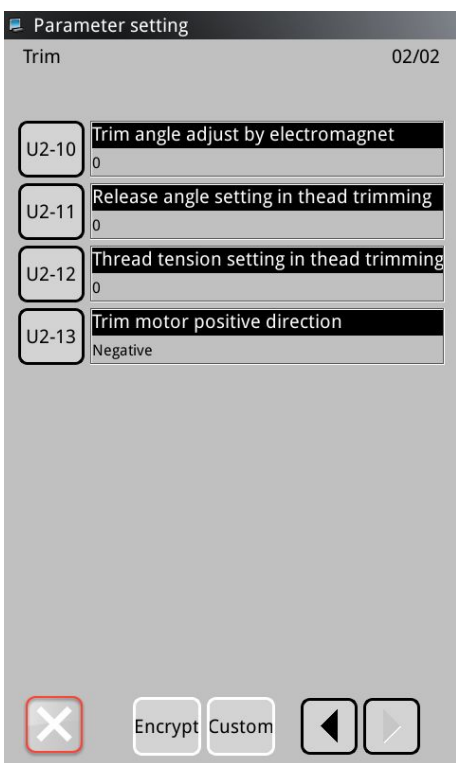

At this time, after returning to the upper interface, the state of [positive direction of wire cutting motor] has changed to [reverse], and the parameter setting is completed.

Examples of input type parameter Settings for reference are as follows:

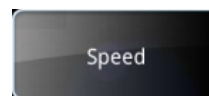
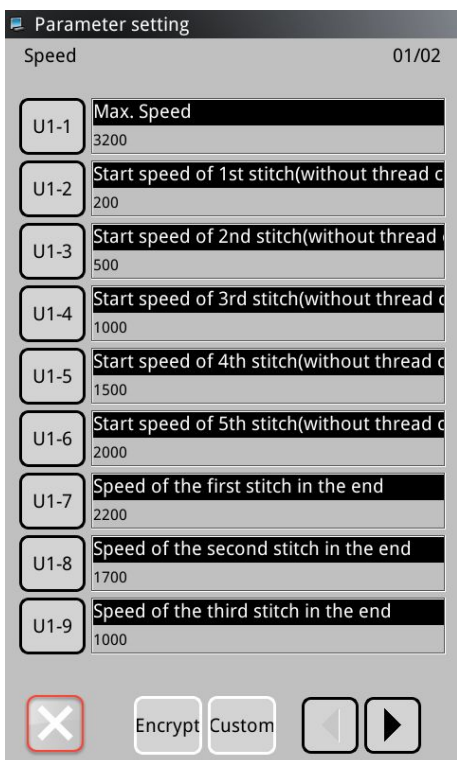

Press the "speed setting" button to enter the parameter setting interface of [speed setting], find the parameter code [u1-1], and set the parameters. At this time, the parameter value of [maximum sewing speed] is [2500].



Press the "u1-1 parameter" key to enter the parameter setting interface of [maximum sewing speed], enter the desired value in the value A through the keypad C, and press



the confirmation button to complete the Settings and changes of the corresponding parameters.

Note: B is the input range of parameter values.

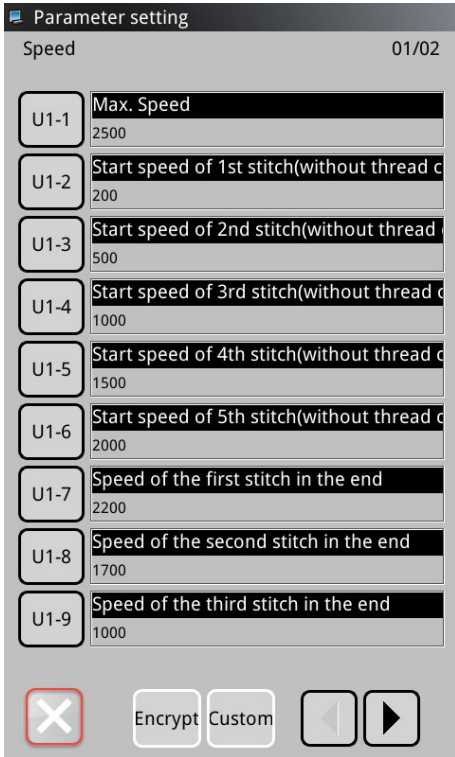

At this time, after returning to the previous interface, the parameter value of [maximum sewing speed] has been changed to [2500] to complete the parameter setting.

5.8 Modified parameter

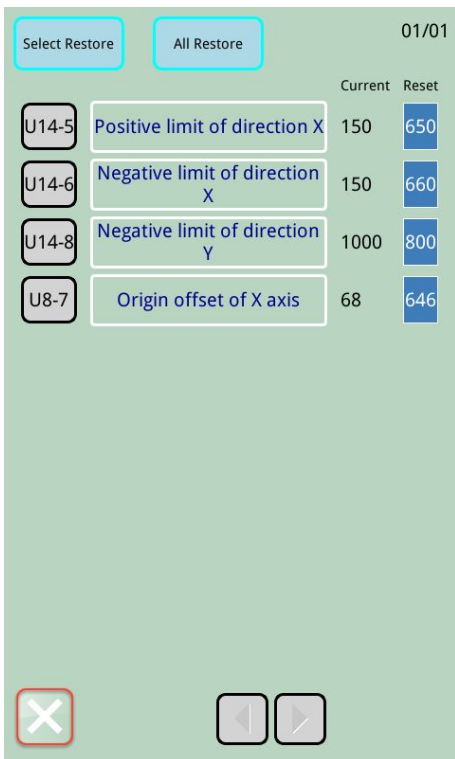

Query for modified parameters

If there is any parameter modification, the "modified parameter" button **Modified** will appear in the lower right corner of the [Settings] interface.

In the [setting] interface, press the "modified parameters" button **Modified** to enter the [modified parameters query] interface to query the modified parameters.

In the "modified parameter query" interface, you can query the list of all modified parameters.

Restore modified parameters

Press "restore all" **All Restore** to restore all modified parameters to factory values.

Click the parameter name key, such as u8-7 "X-axis origin offset" **Origin offset of X axis**, and then press the "select

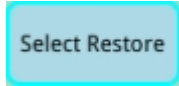

restore" key to restore the selected parameter to the factory value, which also supports check operation



Press the parameter number key, such as u14-5 key, to enter the parameter setting interface and reset the parameter value.



Press "back" to exit the interface.

5.9 Parameters of the custom

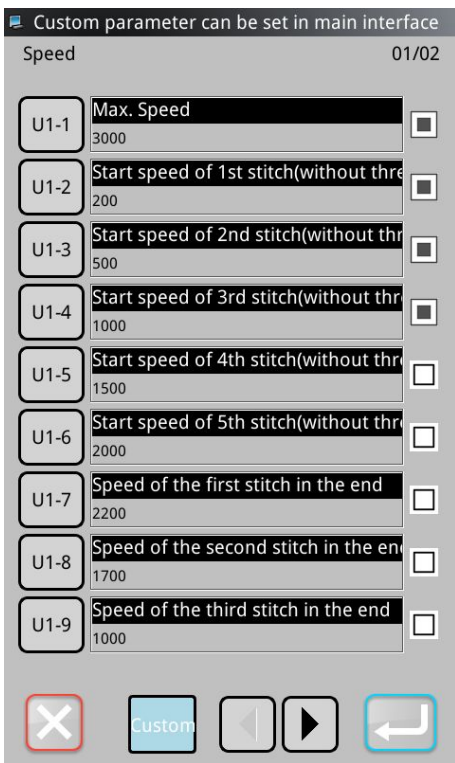

Example "speed setting" parameter customization:

In the [setting] interface, click the "speed setting" button

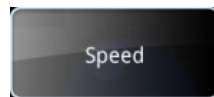

to enter the [speed setting] interface, and click

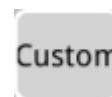

the "customization" button. The system will prompt you to enter the password. After the password is entered successfully, you will enter the [custom speed setting parameters] interface to customize the parameters.

Click the box after the parameter, A indicates that it is not customized as A shortcut parameter, B means customized as a shortcut parameter.



After setting, click "confirm" to confirm



customization, and click "cancel" to exit customization.

Note: custom parameters can be opened in the quick parameters of the main interface.

5.10 User parameter list

U1 Speed setting

No.	Description	Default Value	Range	Step size/unit

U1-1	Maximum sewing speed	3200	200-3200	100
U1-2	Start Speed of 1 st Stitch(No string grab)	200	200-1500	100
U1-3	Start Speed of 2 nd Stitch(No string grab)	500	200-2700	100
U1-4	Start Speed of 3 rd Stitch(No string grab)	1000	200-2700	100
U1-5	Start Speed of 4 th Stitch(No string grab)	1500	200-2700	100
U1-6	Start Speed of 5 th Stitch(No string grab)	2000	200-2700	100
U1-7	End first needle speed	2200	200-2800	100
U1-8	End second pin speed	1700	200-2800	100
U1-9	End third pin speed	1000	200-2800	100
U1-10	End fourth pin speed	600	200-2800	100
U1-11	Start Speed of 1 st Stitch(When have a string grab)	600	200-3200	100
U1-12	Start Speed of 2 nd Stitch(When have a string grab)	900	200-3200	100
U1-13	Start Speed of 3 rd Stitch(When have a string grab)	1200	200-3200	100
U1-14	Start Speed of 4 th Stitch(When have a string grab)	1500	200-3200	100
U1-15	Start Speed of 5 th Stitch(When have a string grab)	1800	200-3200	100
U1-16	Winding speed setting	2500	200-3200	100

U2 Shear line set

No.	Description	Default Value	Range	Step size/unit
U2-1	Is cutting allowed	allow	allow,forbid	
U2-2	Trimming Speed	240	200-800	10/rpm
U2-3	Shear line type	CIR:Round cutter motor cutting wire	MAG: electromagnet wire shear line AIR: pneumatic shear line CIR: round knife motor cutting line EQU: flat knife motor cutting line	
U2-4	Thread-trimming Motor Stroke	88	0-250	1
U2-5	Line trip	50	0-250	1
U2-6	Line time	17	0-200	1/ms
U2-7	Trimming time	90	0-200	1/ms
U2-8	Line Angle	305	0-359	1
U2-9	Stoppage cutting method	MAN: hand cut	AUT: automatic wire	

			cutting MAN: hand cut	
U2-10	Electromagnet trimming Angle	0	-20-20	1
U2-11	Fine adjustment of loose line Angle when cutting line	0	-50-50	1
U2-12	Set the thread tension when cutting the thread	0	0-200	1
U2-13	Positive direction of wire cutting motor	P: positive	P: positive N: reverse	

U3 Medium pressure foot setting

No.	Description	Default Value	Range	Step size/unit
U3-1	Intermediate Presser Type	MO: motor	MO: motor AIR: pneumatic	
U3-2	Closed loop medium pressure foot follow - up mode	10	0-99	1
U3-3	The number of pressing stitches on the middle pressure foot	1	0-5	1
U3-4	Middle pressure foot and auxiliary pressure foot when trying seam	1: rain	0: lift 1: rain	
U3-5	Condition of middle and auxiliary presser foot after disconnection	UP: Lift up	UP : Lift up DOWN: rain	
U3-6	Lower base height a few stitches before seam rise: switch	0: shut down	0: shut down 1: open the starting position of sewing 2: open the middle seam 3: open the seam starting and middle position	
U3-7	Lower base height a few stitches before starting: number of stitches	1	1-15	1
U3-8	Lower base height a few stitches before starting: lower distance	0.1	0.1-2.0	0.1
U3-9	Adjust the follow - up height before sewing: switch	OFF: Closed	OFF : Closed ON: Open	
U3-10	Adjust the follow - up height before seam - up: number of stitches	1	1-15	1

U3-11	Adjust the follow - up height before seam - up: new follow - up height	0.1	0.1-7.0	0.1
U3-12	The middle pressure foot drops at the starting Angle	0	0-359	1
U3-13	Middle pressure foot drop time	0	0-63	1
U3-14	The starting Angle of the middle pressure foot	0	0-359	1
U3-15	Middle pressure foot lift time	0	0-63	1
U3-26	End a few pins before lowering base height: switch	0: Closed	0 : Closed 1: Open	
U3-27	Lower base height before finishing: number of stitches	1	1-15	1
U3-28	Lower base height before finishing: lower distance	0.1	0.1-2.0	0.1

U4 Inflection point speed down

No.	Description	Default Value	Range	Step size/unit
U4-1	Inflection drop switch	ON: Open	OFF : Closed ON: Open	
U4-2	Inflection point speed	1000	200-2000	100
U4-3	Inflection point after the first needle speed	2200	200-2800	100
U4-4	Second needle velocity after inflection point	1900	200-2800	100
U4-5	Inflection point after the third needle speed	1700	200-2800	100
U4-6	The fourth needle velocity after the inflection point	1200	200-2800	100

U5 Laser cutting

No.	Description	Default Value	Range	Step size/unit
U5-1	Enable switch of laser cutter	OFF: Closed	OFF: Closed ON: Open	
U5-2	X cutter offset	0	-500.0-500.0	0.1
U5-3	Y cutter offset	0	-500.0-500.0	0.1
U5-4	Synchronous delay of cutter	50	0-255	1

U5-5	Delay in laser cutting section	1	1-30000	1
U5-6	Laser cutting first delay	1	1-30000	1
U5-7	Laser cutting total power hold time	0	0-100	1
U5-8	Whether the head of the laser section is raised or not	ON: allow	OFF: forbid ON: allow	
U5-9	Lift cylinder origin signal detection enable	ON: Open	OFF: Closed ON: Open	
U5-10	Frequency of abnormal protection of laser cutter communication	1	1-10	1

U6 Moving frame speed and timing

No.	Description	Default Value	Range	Step size/unit
U6-1	Empty speed gear	2	0-9	1
U6-2	Sew the end back to the original speed gear	2	0-9	1
U6-3	Try sewing speed gear	50	1-100	1
U6-4	X axis seam - up frame Angle fine adjustment	0	-120-120	1
U6-5	Y axis from the seam frame Angle fine adjustment	0	-120-120	1
U6-6	X axis moving frame Angle fine adjustment	0	-120-120	1
U6-7	Y axis moving frame Angle fine adjustment	0	-120-120	1
U6-8	X axis moving frame time adjustment	0	-100-100	1
U6-9	Y axis moving frame time adjustment	0	-100-100	1

U7 Head and tail reinforcement and breakage detection

No.	Description	Default Value	Range	Step size/unit
U7-1	The number of starting stitches	0	0-2	1
U7-2	Initial pin reinforcement mode setting	2: reinforce the first few stitches	0: not reinforced 1: reinforce in the first stitch 2: reinforce the first few stitches 3: zigzag seam reinforcement	
U7-3	Number of stitch reinforcement	2	-4-4	1
U7-4	End pin reinforcement mode	3: end N type	0: not reinforced	

	setting	reinforcement three pins	1: reinforce one stitch at 0.1mm before the end stitch 2: end N type reinforcement two pins 3: end N type reinforcement three pins 4: at the end of N type reinforcement four pins 5: at the end of V - type reinforcement two pins	
U7-5	Break detection whether open	ON: Open	OFF : Closed ON: Open	
U7-6	Trigger mode of broken wire sensor	H: high level	L: low level H: high level	
U7-7	The number of invalid stitches at the beginning of sewing during thread breakage detection	8	0-15	1
U7-8	Invalid number of stitches in the middle of sewing during thread breakage test	5	0-15	1

U8 Spindle stop with origin

No.	Description	Default Value	Range	Step size/unit
U8-1	Machine needle stop position	UP : On the position	UP : On the position DEAD : Top dead center	
U8-2	Return to the original point of machine needle stop position	UP : On the position	UP : On the position DEAD : Top dead center	

U8-3	Dead point Angle on machine needle	0	0-80	1
U8-4	Machine needle position Angle	53	30-80	1
U8-5	Return to the original point after sewing	YES: YES	NO : NO YES: YES	
U8-6	Return to origin after sewing	3: XY all look for the origin through the sensor	0: x, y find the origin of the coordinates 1: X looks for the origin through the sensor, and Y looks for the origin through the sensor 3: XY all look for the origin through the sensor 4: empty send to the sensor position to find the origin	
U8-7	X axis origin deviation	646	-3000-3000	1
U8-8	Y-axis origin offset	-2	100.0-100.0	0.1
U8-9	If XY looks for the origin of the sensor when switching to the sewing state	0: NO	0 : NO 1: YES	

U9 Line clamp and line dipper

No.	Description	Default Value	Range	Step size/unit
U9-1	Type selection of wire clamp	M: mechanical	M: mechanical E: electronic	
U9-2	Whether the needle clamp is open before seam opening	OFF: Closed	OFF : Closed ON: Open	
U9-3	Whether the wire clamp is open before empty feeding	OFF: Closed	OFF : Closed ON: Open	

U9-4	The wire clamp is turned on to hold the current	0	0-255	1
U9-5	Whether to open the small sewing clamp	0 : Closed 1: Open	0 : Closed 1: Open	
U9-6	Type of line extractor	0: blowing line	0: blowing line 1: electromagnet pulling wire 2: cylinder dial line	
U9-7	Blowing qigong can enable energy	ON1: cut and turn on	OFF: Closed ON1: cut and turn on ON2: open before seam opening	
U9-8	Start time of blowing after cutting line	0	0-200	1/10ms
U9-9	Duration of blow	10	10-200	1/100ms
U9-10	Open duration of electromagnet dial line	50	10-500	10/ms
U9-11	Electromagnet dial - off duration	80	10-500	10/ms

U10 Template identification with press box

No.	Description	Default Value	Range	Step size/unit
U10-1	Template recognition switch	ON: Open	OFF : Closed ON: Open	
U10-2	The template identifies the device type	RF: RF Card	BAR: Bar code scanning equipment RF : RF Card	
U10-3	Template recognition is not allowed until the frame is lowered	0- close: the press box can be identified both up and	0- close: the press box can be identified	

		down	both up and down 1- open: the frame can be identified only after it is lowered	
U10-4	Frame pressing after sewing	0: return to the origin and then lift	0: return to the origin and then lift 1: lift up first and then return to the origin 2: step on the pedal to lift after returning to the origin	
U10-5	Is pressing frame allowed to lift after emergency stop	OFF: forbid	OFF : forbid ON: allow	

U11 Change shuttle and cutter

No.	Description	Default Value	Range	Step size/unit
U11-1	Enable automatic shuttle change	OFF: Closed	OFF : Closed ON: Open	
U11-2	Shuttle motor zero compensation	0	-127-127	1
U11-3	Shuttle changing way	0: change the shuttle after the bottom line alarm	0: change the shuttle after the bottom	

			line alarm 1: automatic shuttle change after baseline alarm	
U11-4	Change the shuttle stitch	0: manual start	0: manual start 1: automatic start	
U11-5	Shuttle stop position	0: side of the shuttle disk	0: side of the shuttle disk 1: nose side	
U11-6	Handling method of empty shuttle center	0: return to the shuttle	0: return to the shuttle 1: put in a storage box	
U11-7	Correction and compensation of nose butt position	0	-127-127	1
U11-8	Shuttle docking position correction and compensation	0	-127-127	1
U11-9	Hold the cylinder in place before and after the delay	2000	0-20000	1
U11-10	Clamping cylinder in place delay	500	0-20000	1
U11-11	Working current gear of grab motor	5	1-10	1
U11-12	Rotate the cutter to enable	OFF: Closed	OFF : Closed ON: Open	
U11-13	Rotation cutter zero position Angle setting	0	-120-120	1
U11-14	Cutter speed gear	3	1-10	1
U11-15	Wait time after rotation of cutter	1000	0-20000	1
U11-16	Waiting time after lifting the cutter	3000	0-20000	1

U11-17	Operating current gear of cutter motor	4	1-10	1
U11-18	The linear cutter enables	OFF: Closed	OFF : Closed ON : enabled	
U11-19	Linear cutter origin compensation	0	-127-127	1
U11-20	The straight cutter drops height	210	0-360	1
U11-21	Linear cutter swing amplitude	80	10-100	1
U11-22	Synchronous delay of linear cutter	0	0-50	1

U12 Maintenance and maintenance Settings

No.	Description	Default Value	Range	Step size/unit
U12-1	Sewing counter counting unit	1	1-30	1
U12-2	Oiling Interval	30	0-65535	1/s
U12-3	Oiling the Work Time	900	0-65535	1/ms
U12-4	Disallow counter to be modified	OFF: allow modification	OFF: allow modification ON: no modification	
U12-5	Operation of the sewing machine when the counter reaches the set value	OFF:stop sewing	OFF:stop sewing ON: continue sewing	
U12-6	Oil box filling time setting	84	0-9000	1/h
U12-7	Grease maintenance time setting	360	0-9000	1/h
U12-8	Baseline alarm setting	0: alarm in sewing	0: alarm in sewing 1: early alarm	
U12-9	Insufficient oil tank alarm switch	OFF: Closed	OFF: Closed ON: Open	

U13 Set the panel

No.	Description	Default Value	Range	Step size/unit
U13-1	Buzzer sound setting	ALL : operation disc	OFF : no buzz	

		sound+Alarm sound	PAN: operation disc sound ALL: operation disc sound+Alarm sound	
U13-2	Backlight automatically turns off	OFF: not automatically OFF	OFF: not automatically OFF ON: auto off	
U13-3	Backlight automatically turns off wait time	3	1-9	1/m
U13-4	LCD backlight brightness adjustment	100	20-100	1
U13-5	The volume size	50	30-63	1
U13-6	Voice choice	English	ZH : 中文 EN : English TU : Türk HAN : VIE:	
U13-7	Boot whether to enter the language selection	OFF: NO	OFF : NO ON: YES	
U13-8	Set the voice	OFF: Closed	OFF : Closed ON: Open	
U13-9	Main control burning address	851968	655360-917504 Main control burning address : 0xA000:655360 0xB000:720896 0xC000:786432 0xD000:851968	1

			0xE000:917504	
U13-10	Main interface icon text mode switch	WORD : WORD	ICON : ICON WORD: WORD	
U13-11	Network setting	OFF: Closed	OFF : Closed WLAN0 : WIFI ETH0 : The cable	
U13-12	Dimension change unit	% : percentage	% : percentage SIZ: actual size	
U13-13	Zoom in and out mode	PIT: interval plus or minus	OFF: ban PIT: interval plus or minus STI: increase or decrease of the number of injections	
U13-14	Pattern enlargement and reduction	ORI1: take the origin as the reference point	ORI1: take the origin as the reference point ORI2. : take the origin as the reference point (ignore the air feed before seam) CEN. : take the center of the pattern as the reference point (ignore the air delivery before sewing).	
U13-15	Whether to support large stitch number pattern	ON: YES	OFF : NO ON: YES	
U13-16	Voice recognition function Settings	OFF: Closed	OFF : Closed	

			ON: Open	
--	--	--	----------	--

U14 Other Settings

No.	Description	Default Value	Range	Step size/unit
U14-1	Sewing patterns	HAR2: lead screw hard mode	SOF: soft belt mode DEF: belt anti-drilling fleece HAR: belt hard mode SOF2: lead screw soft mode HAR2: lead screw hard mode	
U14-2	Model selection	8: M6 lead screw template machine	0: standard model 1: medium model 2: high-end model 3: automatic machine 4 : 900 models 5: linear cutter machine 6 : 800 model 7:60037 model 8: M6 lead screw template machine	1
U14-3	Barometric switch	ON: Open	OFF : Closed ON: Open	
U14-4	Emergency stop switch polarity	OFF: normally closed	OFF: normally closed ON: normally open	
U14-5	Move the limit +X direction	650	0-2000	1/mm
U14-6	Move the limit -X direction	660	0-2000	1/mm
U14-7	Move the bounds plus the Y direction	0	0-1000	1/mm
U14-8	Move the limit -Y direction	800	0-1000	1/mm
U14-9	Restore factory parameters	1	Factory default parameters Factory parameters01(Haved)	
U14-10	Start mode setting	TWO: double start	NOR: normal startup TWO: double start	

U14-11	Start sewing to start seam path set	1: empty send the path to the seam starting point according to the pattern	0: straight line to start seam point 1: empty send the path to the seam starting point according to the pattern	
U14-12	Whether the machine is started directly into the sewing state	NO: NO	NO : NO YES: YES	
U14-13	Brush X offset	0	-500-500	1/mm
U14-14	Brush Y offset	0	-500-500	1/mm
U14-15	Brush speed	1	1-9	1
U14-16	Whether the cable is open	OFF: Closed	ON : Open OFF: Closed	
U14-17	Grasp the position of the wire	59	0-100	1
U14-18	Catch line suction time	1	0-30	1
U14-19	Hold the line and hold the Angle fine adjustment	-4	-100-100	1
U14-20	Set the number of stitches to release the line	2	1-7	1
U14-21	Return switch after break	0: Closed	0 : Closed 1: return after broken line open: return cannot cross the empty send 2: short backtrack open: backtrack is allowed across empty send	
U14-22	Number of retractable stitches after broken wire	5	1-50	1
U14-23	X step Angle fine adjustment	0	-100-100	1
U14-24	Y step Angle fine adjustment	0	-100-100	1

6 Winding

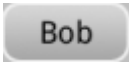

In the interface of "pattern sewing" or "pattern selection", click "winding"  to enter the interface of "winding".

7 Information

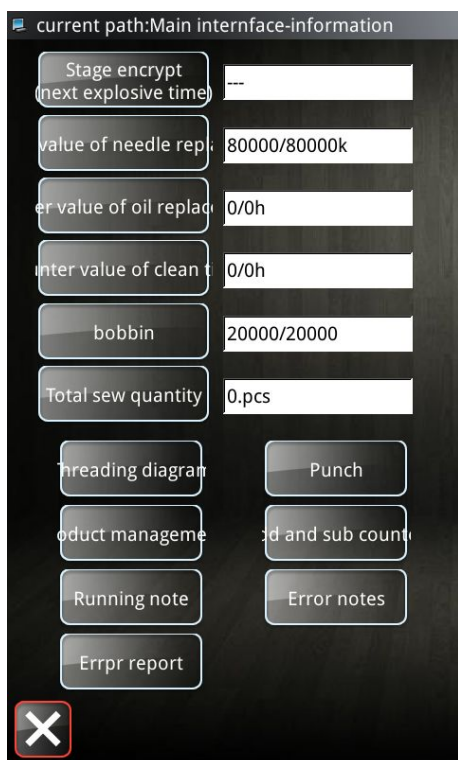

Press the "information" button  in the pattern selection interface, and exit from the sewing state before entering.

The following values can be set:

- 1) change the needle count
- 2) change the oil count
- 3) cleaning time count
- 4) bottom line count
- 5) cumulative number of sewing pieces

7.1 Periodical Password

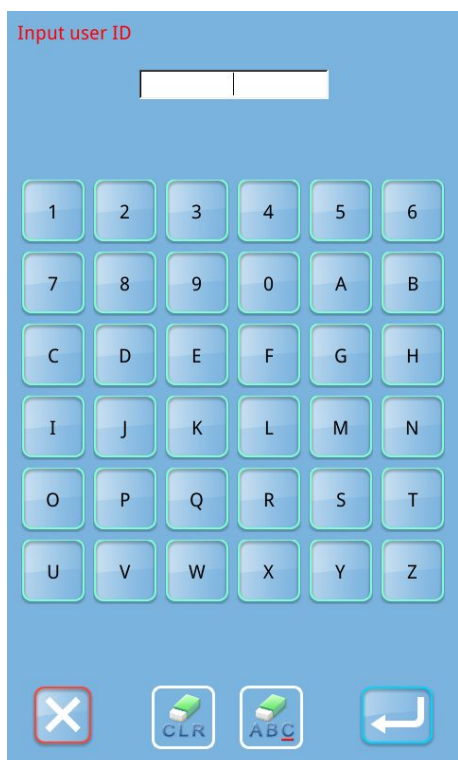

(1) Under the [information] interface, click "staging password"

, and the interface of [input user ID] will

be displayed. Enter the correct manufacturer ID and enter the password management mode, which is mainly used for setting and managing the staging password of users.

- At most ten periodical passwords with different activation dates can be set.
- The system will display the information of passwords set by manufacturer.



(2) Enter the correct manufacturer ID, enter the password setting interface

Before setting the password, user has to set board number and system clock, where user can set and manage the periodical passwords.



(3) Enter the board number

Press to enter the board number input interface. Input the

board number and press  to finish the input.

Note: The board is a four-figure number, from 0~9999

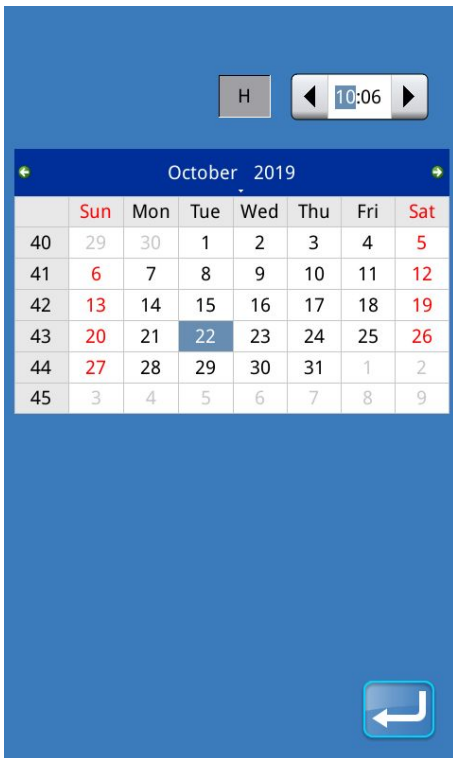

(4) Input System Clock

Press the "clock" button to enter the interface of system clock setting to determine the system clock.

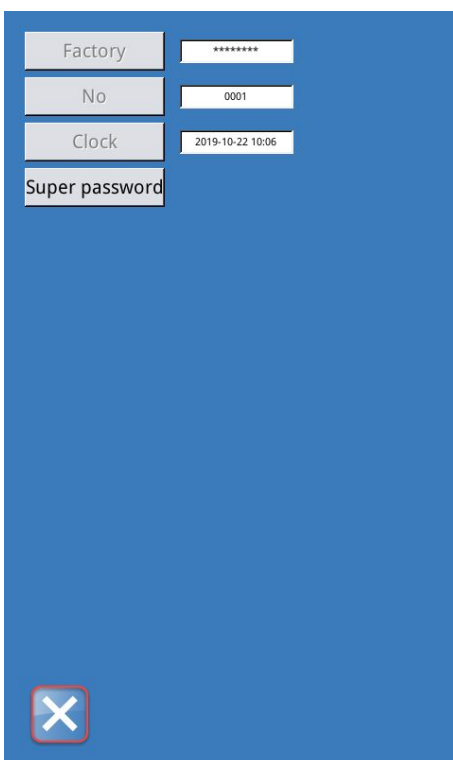

(5) Input the super password

Press the "Super Password" to enter the interface for setting super password.

- ※ You can enter up to 9 super passwords
- ※ Password input request confirmation, two passwords must be consistent

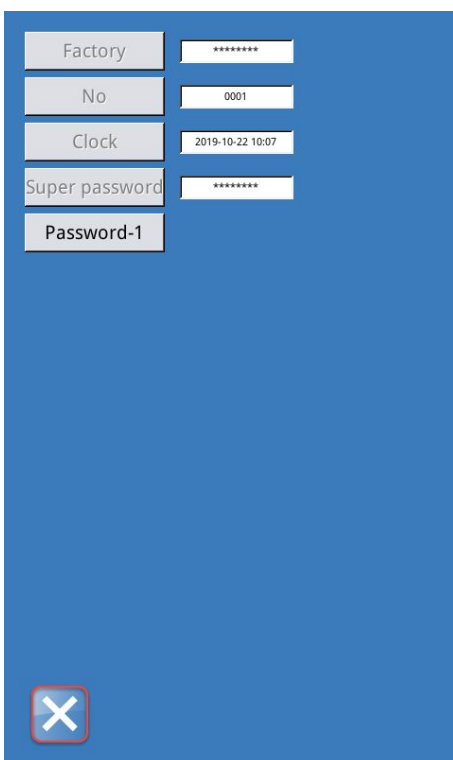
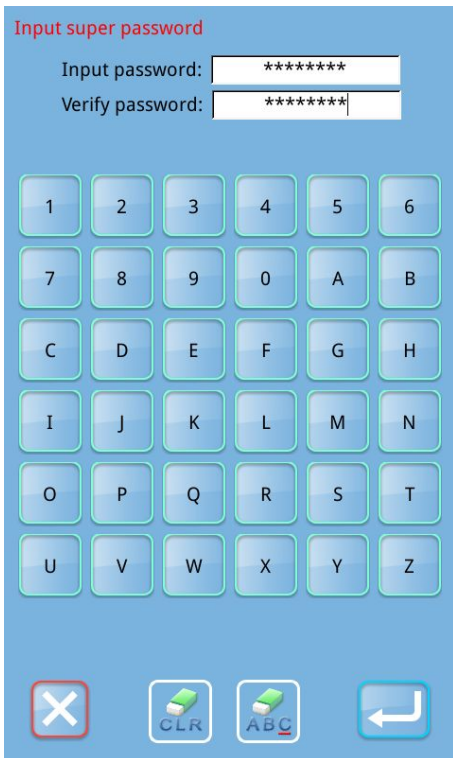

(6) Input periodical password

Press "Password-1" to enter the first password date, where user can input the first date for activation. After selecting the

proper date, user can press  for confirmation.

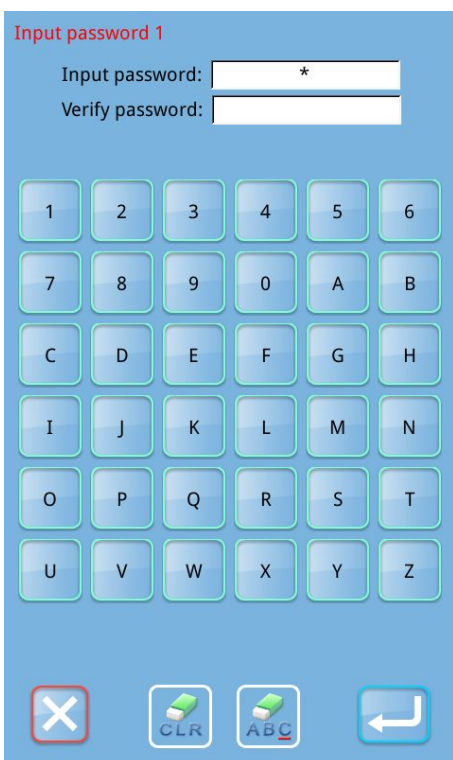
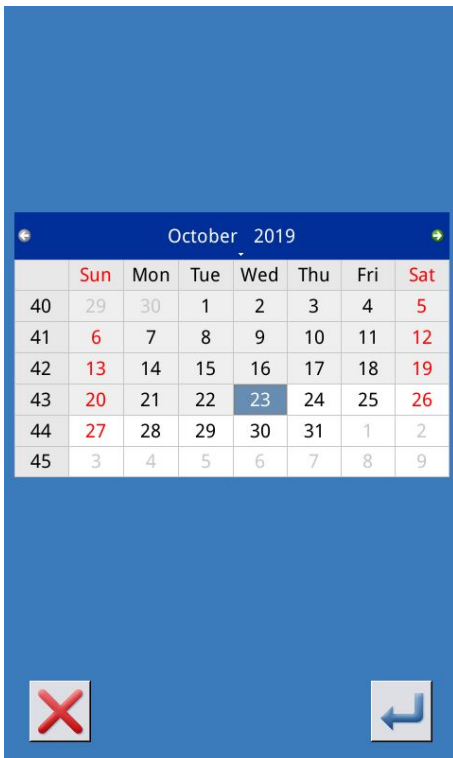

Then enter the password setting interface to input the password.

- ※ The date should not be earlier than the system date
- ※ Password input request confirmation, two passwords must be consistent

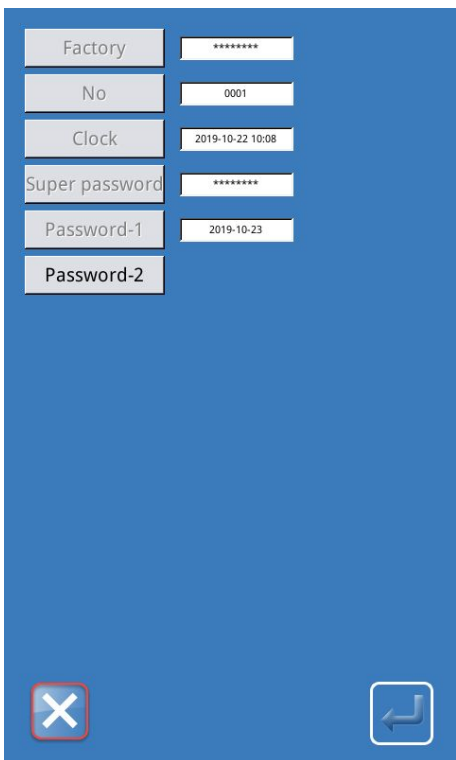

5) Input other periodical passwords

The setting of other periodical password is the same with Password-1. Please make reference to that.

※ **The date should not be earlier than the system date**

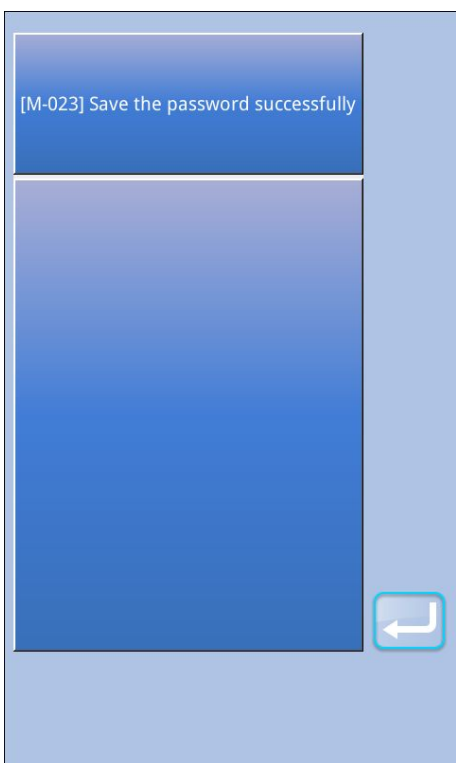

6) Save password

After inputting the password, please press  to save it. After the password is saved, the system will display "Save the password successfully".

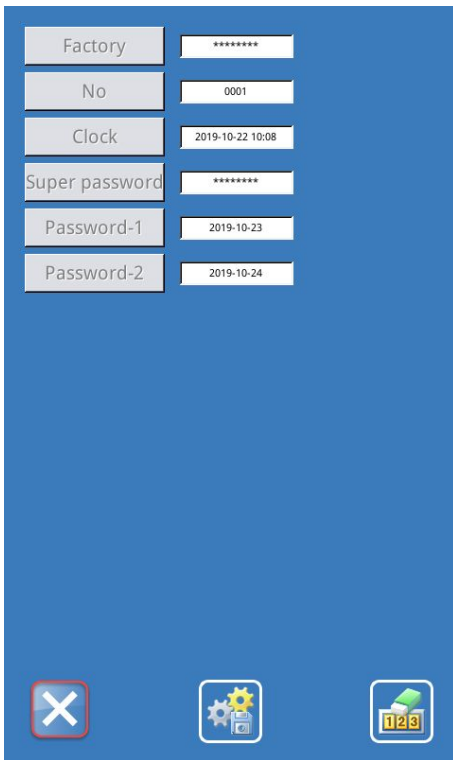

7) Clear Password before Activation

It is to clear the passwords before its activation.

A、 The method for entering the password interface is same to that of the password setting.

B、 Input the right manufacturer ID to activate the right interface.

C、 The system will display current clock and the activation dates.

D、 Press  to delete the password orderly.

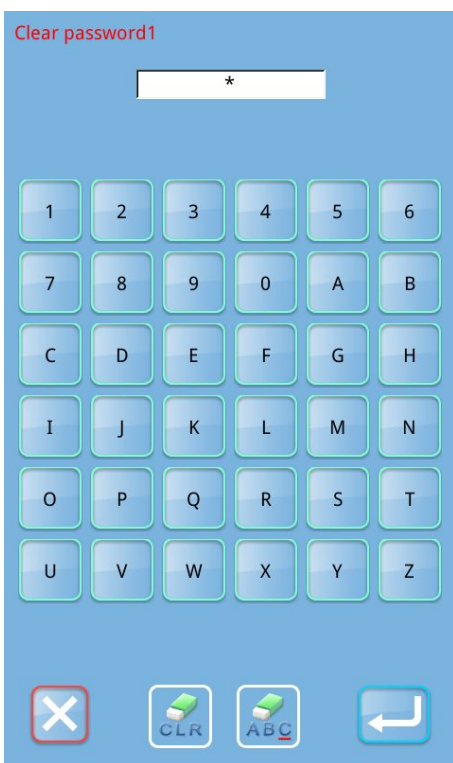

Clear the current password after entering the correct staging password, and clear all passwords when entering the super password.

After clearing the password, it will be displayed in red text. If all the passwords are cleared, it will exit automatically and return to the main information interface.

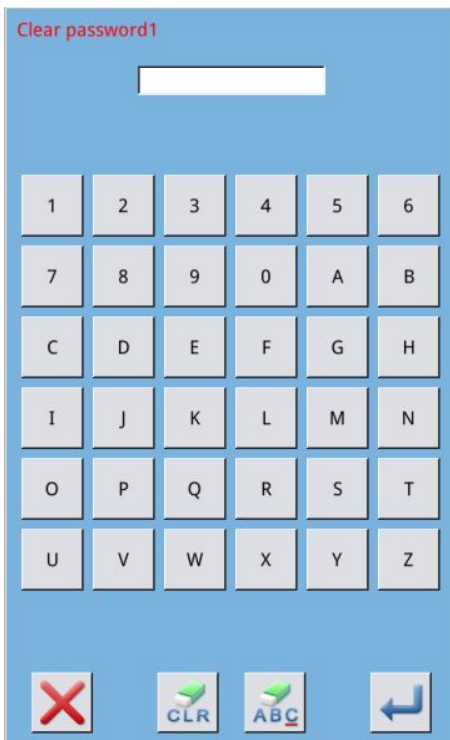

8) Password attack

If the system sets a password, a password attack will occur when the password attack date is used.

At this point, if continue to use, must enter a valid password.

A. valid password includes current prompt password and super password.

B. If the current password is entered, clear the current password. Clear the current password, if there is no password, the machine will no longer appear password attack problem.

C. If the super password is entered, clear all the staging passwords.

7.2 Threading motioned

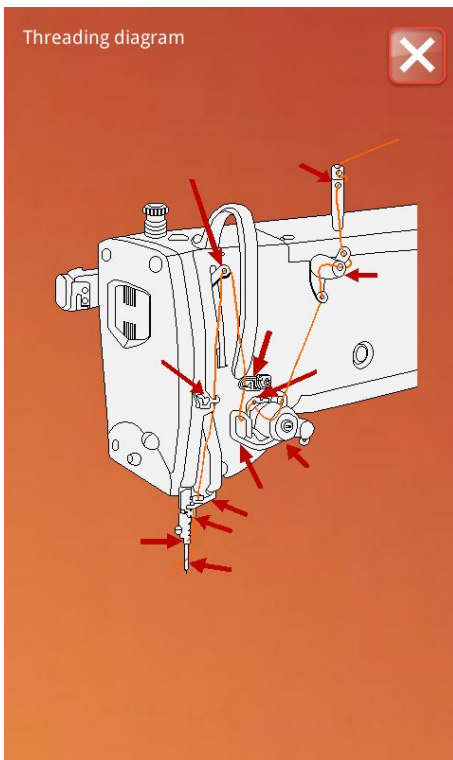

Under the [information] interface, click "threading"

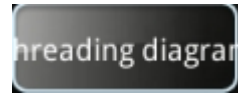

to enter the [threading] interface. When threading, please refer to.

7.3 Clock in

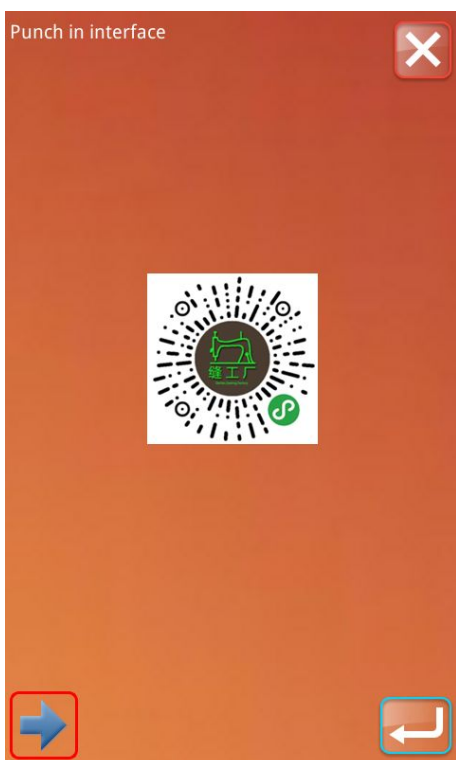

In the [information] interface, click "punch"

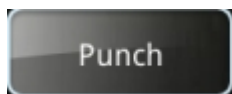

to enter the intelligent punch interface, as shown in the left picture.

If the network is connected normally, employees can scan the qr code in the picture and punch in.



Or click the "switch" key to switch the way of punching in, employees can enter their own work number, click the "OK" key to send their information to the server.

If the smart factory server holds relevant employee information, the employee's work statistics will be recorded in the server.

Managers can easily calculate the output, salary and other information of employees by querying relevant work statistics through the intelligent factory client.

Note: only the panel with WIFI function can use this function normally.

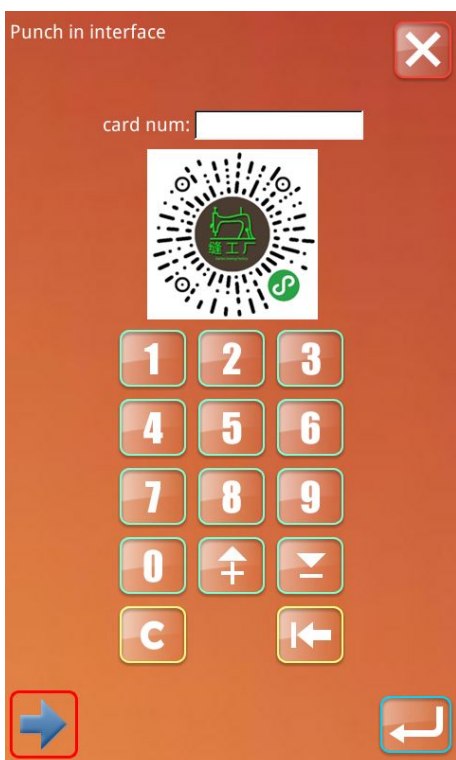

7.4 Production management parameters

See [6.5 维护与保养设置](#)

7.5 add-subtract counter

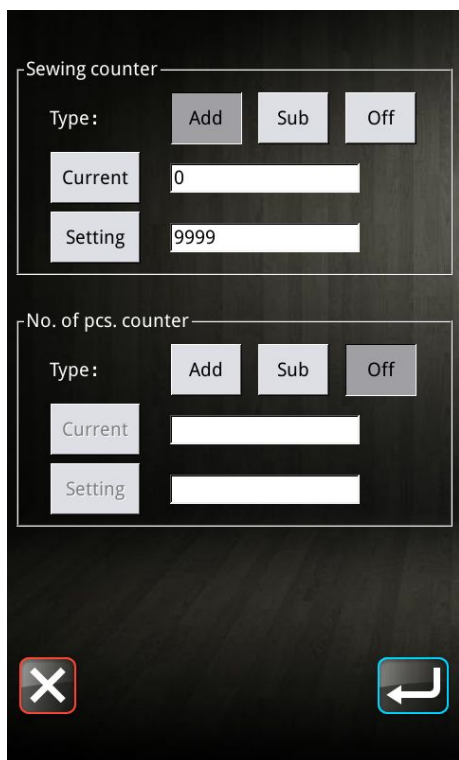

Under the [information] interface, press the "Add and sub counter" button to enter the [counter] setting interface.

Sewing counter: add/subtract 1 counter per sewing item.

Piece counter: add/subtract 1 counter per sewing cycle.

Piece counter is mainly for C pattern counting, if other sewing types are used, piece counter and sewing counter function the same.

1) Counter value setting

Current: Press to set the current value of the counter.

Setting: After pressing the button, the counter can be set. When the set value is 0, the counter will not work.

2) Counter type setting

Add: Set to counter type, when the current value reaches the set value will prompt an alarm.

Sub: Set to decrement counter type to alert when current value is 0.

Off: Turn off the counter function.

Note: parameter u12-4: prohibit counter from being modified. If set to "prohibit modification", the interface cannot be entered.

Note: parameter u12-5: operation of the sewing machine when the counter reaches the set value. If it is set as "sewing can continue", the current value of the counter will overflow without alarming, and will automatically return to the target value (adding counter returns to 0, and subtracting counter returns to the set value).

7.6 Run Note

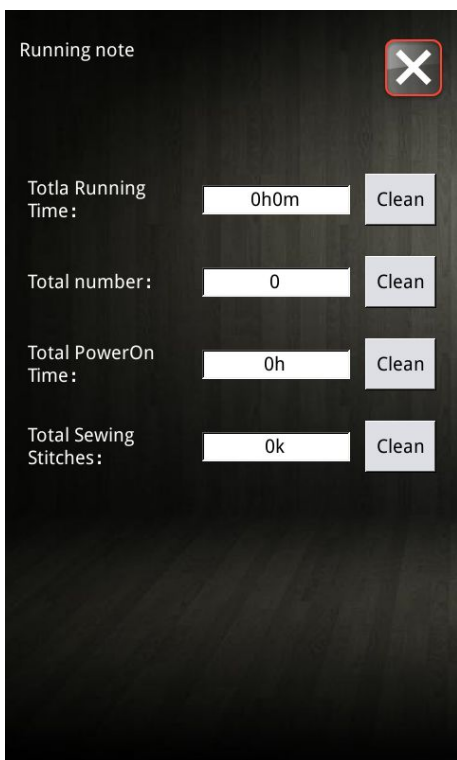

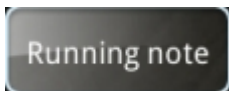
Under the [information] interface, press the "operation record" key  to enter the [operation record] interface.

Accumulated Running Time : Record total sewing time of machine (Unit: hour)

Accumulated Sewing Pieces : Record the total number of the sewn patterns

Accumulated Power-on Time : Record the total time of power-on (Unit: hour)

Accumulated Power-on Tim : Record the total stitch number of the machine (Unit: 1000 Stitch,)

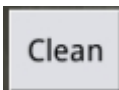
Press the "clear" key  to clear the record values separately.

7.7 The alarm record

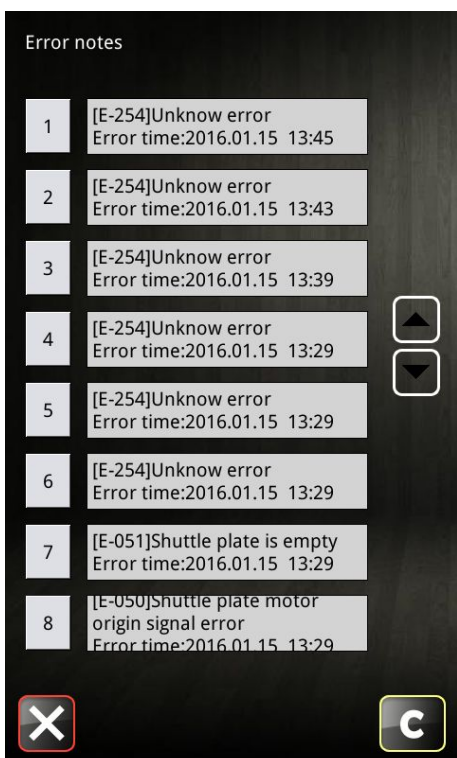

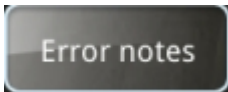
Under the [information] interface, press the "alarm record" key  to enter the [alarm record] interface.

The interface displays the contents of the fault information that occurs in the system. The smaller the sequence number, the newer the time when the fault information occurs.

The production count of each alarm was also recorded.

You can scroll through the  or  keys to see more error messages

Pressing the  key will erase all fault information records.

7.8 Error reporting

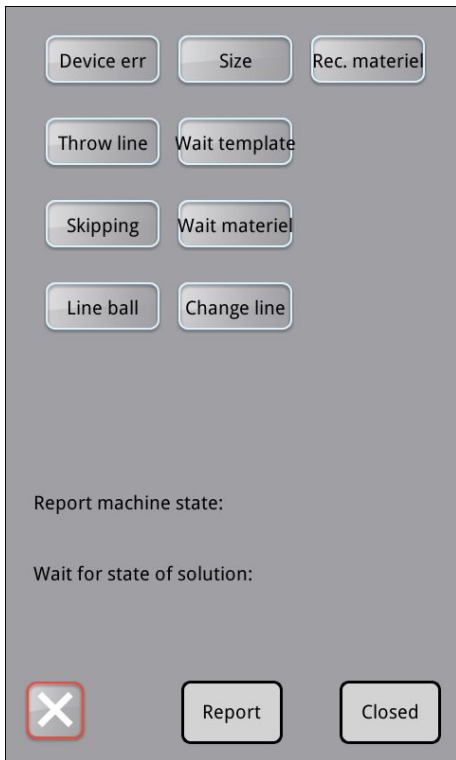

In the [information] interface, press the "error report"

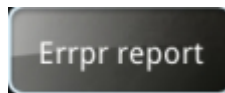

button to enter the [error report] interface.

Click to select machine state:

- 1) equipment failure
- 2) size
- 3) receiving materials
- 4) casting
- 5) wait for the template
- 6) jump needle
- 7) waiting for materials
- 8) ball line
- 9) line changing and debugging



: Report machine status

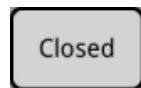

: When the error is resolved, click close

8 Appendix 1

8.1 List of alarm information

Number	Fault Name	Solution
E001	The pedal is not in the correct position	Please adjust the pedal position
E002	Machine is in emergency stop	Please check the status of emergency stop switch
E003	Confirm nose down	Self recovery error
E004	The main voltage (300V) is too low	Please turn off the power and check the system hardware
E005	The main voltage (300V) is too high	Self recovery error
E007	Voltage of assistant device (24V) is too high	Please turn off the power and check the system hardware
E008	Auxiliary equipment voltage (24V) is too high	Please turn off the power and check the system hardware
E009	Auxiliary equipment voltage (24V) is too low	Please turn off the power and check the system hardware
E010	Air valve short circuit or fan block	Please turn off the power and check the system hardware
E011	X motor overspeed fault	Please turn off the power and check the system hardware
E012	X motor out-of-tolerance fault	Please turn off the power and check the system hardware
E013	Thread breakage detection error	Please turn off the power and check the system hardware
E014	Emergency switch is not at the right position	Please turn off the power and check the system hardware
E015	X origin detection abnormal	Please press ok to remove the fault
E016	Abnormal position on pin rod	Please press ok to remove the fault
E017	Broken line detection error	Please press ok to remove the fault
E018	The position of the line cutter is abnormal	Please turn off the power
E019	Emergency stop switch not in normal position	Please check the emergency stop switch
E020	Step software version error	Please turn off the power
E023	Catch line position abnormal	Please turn off the power
E024	Incorrect connection between	Please turn off the power

	operation head and sewing machine	
E025	IPM over current frequently 2	Please turn off the power
E026	Motor is blocked 1	Please turn off the power
E027	The origin of presser foot is abnormal	Please turn off the power
E028	Catch the origin of the line to detect abnormalities	Please turn off the power
E029	Machine stop over-current	Please turn off the power
E030	Presser not down	Please turn off the power
E031	X-axis motor overcurrent	Please turn off the power
E032	Step drive power supply abnormal	Please turn off the power
E034	X motor over-current	Please turn off the power
E035	Y motor over-current	Please turn off the power
E036	X motor position error	Please turn off the power
E037	Y motor position error	Please turn off the power
E038	Servo motor communication error	Please turn off the power
E039	Not enough bobbin thread	Please turn off the power
E040	Write driver software unsuccessfully	Please turn off the power
E041	Motor overload	Please turn off the power
E042	Bus voltage abnormal	Please turn off the power
E043	Y motor overspeed fault	Please turn off the power and check the system hardware
E044	Y motor out-of-tolerance fault	Please turn off the power and check the system hardware
E045	Bottom line count insufficient	The set value of changing the bottom line has reached, please change the bottom line
E046	Medium pressure foot motor overcurrent	Please turn off the power and check the system hardware
E047	Main control stepping curve parameters mismatch	Please turn off the power and check the system hardware
E048	Air pressure is insufficient	Please check whether the air path is normal
E049	Wrong origin signal of motor of shuttle changing manipulator	Please turn off the power and check the system hardware
E050	Origin signal error of shuttle motor	Please turn off the power and check the system hardware
E051	The spindle disk is empty	Check the shuttle detector and load the shuttle
E052	Step drive upgrade failed	
E053	Intermediate presser motor over-current	

E054	Thread-trimming motor over-current	
E055	Fast walk curve miscalculated	
E056	SPI communication end code exception	
E057	SPI communication verification failed	
E058	Fast walk receive data abnormal	
E059	X motor is blocked	
E060	Y motor is blocked	
E061	X motor instruction coverage	
E062	Y motor instruction coverage	
E063	X motor quick walk instruction coverage	
E064	Y motor quick walk instruction cover	
E065	Moving frame curve calculation is abnormal	
E066	Template recognition failed	
E067	Grip motor overcurrent	
E068	Abnormal origin position of cutter motor	
E069	The emergency stop coordinate is abnormal	
E070	Stop waiting timeout	
E071	Cutter motor out of tolerance	
E080	Insufficient oil in oil box, please add lubricating oil	
E081	Master pattern receiving abnormal	
E090	Stepper motor 3 communication abnormal	Please turn off the power
E097	RF read-write anomaly	Please turn off the power
E098	Abnormal position of laser safety switch	Please check the safety switch
E099	Abnormal lifting of cutter	Please turn off the power
E100	Abnormal action of cutter servo motor	Please turn off the power
E101	The origin of the shear line motor is abnormal	Please turn off the power
E102	Shear line motor out of tolerance	Please turn off the power
E103	Wire cutting motor overcurrent	Please turn off the power
E254	Undefined error	Undefined error

8.2 List of information tips

No.	Name	Content of Sub-information
M-001	Pattern data not exist	Please reload or input again
M-002	Set value is too large	Please input value within valid range
M-003	Set value is too small	Please input value within valid range
M-004	Save parameter abnormal	Press Enter to restore the default values
M-005	Communication error	There is problem with the communication between the operation panel and the control box.
M-006	Please exit the sewing state	
M-007	Operation panel not match to machine type	Please check the model and the software version
M-008	Exceeding maximum stitch length	
M-009	Wrong password	Please input again
M-010	Hardware clock error	The hardware clock has problem, please contact manufacturer for repair.
M-011	Please unlock	
M-012	SRAM initialization	Clear all data in SRAM. Please turn off power and restore the setting of DIP switch.
M-013	Turn off machine, Bye	
M-014	USB is pulled out	USB is pulled out
M-015	Cannot find pattern data in U disk	
M-016	At least input one letter	At making pattern of letter sewing, user has to input at least one letter
M-017	No alarm record	
M-018	Wrong User ID	Please input again
M-019	Fail to conform password	Please input password again
M-020	Cannot change system time	The periodical password is set. Can not change system time.
M-021	Fail to save password file	
M-022	Fail to load password file	
M-023	Password saved successfully	
M-024	Fail to clear all passwords	Cannot delete password file
M-025	Fail to clear password	After the password is cleared, the file input becomes abnormal
M-026	Password file is deleted without authorization	Periodical password is deleted without authorization, please turn off machine
M-027	User ID file damage	

M-028	Empty input invalid	Please enter password
M-029	Password not match	Please re-enter your current password
M-030	New password is different.	Please re-enter your new password and confirm it again
M-031	Enter touching panel correction mode?	Yes: Enter No: X
M-032	Touching panel correction successful	Correction is successful. Please turn off power to restart.
M-033	Fail to correct touching panel	Please perform correction again
M-034	Clear alarm records?	Yes: Enter No: X
M-035	Periodical passwords can't be same to super password	Please input password again
M-036	Pattern data error	Current pattern data error, will be replaced by factory pattern!
M-037	The pattern information file failed to open	Restore factory pattern configuration!
M-038	The number of patterns is full	Please delete the unused pattern after the operation!
M-039	Whether to cover pattern	Yes: Enter No: X
M-040	P pattern open unsuccessfully	Wrong pattern file will be deleted
M-041	C pattern open unsuccessfully	Wrong pattern file will be deleted
M-042	Patterns exist	Cannot perform an override operation
M-043	Whether to delete pattern data	Press ok to perform the delete operation, and press cancel to exit the current operation.
M-044	Delete the selected file?	Yes: Enter No: X
M-045	The pattern is quoted and cannot be deleted!	Please unquote in P pattern or C pattern
M-046	Please keep at least one pattern!	The last pattern cannot be deleted
M-047	Loaded factory pattern	There is no pattern in memory and factory pattern needs to be loaded
M-048	Cannot find pattern in memory	Press Enter to load the default patterns
M-049	The input number does not exist	Please input again
M-050	P patterns do not exist	Please create the P pattern first
M-051	Save software version successfully	The software version has been successfully saved to the U disk root directory
M-052	Replace needle	Reach set value for needle replacement, please replace needle!
M-053	Replace oil	Reach set value for oil replacement, please replace oil!
M-054	Clean machine	Reach set value for cleaning machine, please clean machine!
M-055	Determine the clear changing machine needle value	Yes: Enter No: X
M-056	Determine the clear oil change meter value	Yes: Enter No: X

M-057	Determine the cleaning time count	Yes: Enter No: X
M-058	Determine clear production management count	Yes: Enter No: X
M-059	Clear accumulated running time?	Yes: Enter No: X
M-060	Clear accumulated sewing pieces?	Yes: Enter No: X
M-061	Clear accumulated power-on time?	Yes: Enter No: X
M-062	Clear accumulated stitch numbers?	Yes: Enter No: X
M-063	Determine the number of clear cumulative overflows?	Yes: Enter No: X
M-064	Determine the number of cumulative parking errors cleared?	Yes: Enter No: X
M-065	Do you edit new designs?	Yes: Enter No: X
M-066	Return to sewing mode?	Yes: Enter No: X
M-067	Restore all the settings?	Yes: Enter No: X
M-068	Restore the selected item?	Yes: Enter No: X
M-069	Not select item	Please select one or more parameters
M-070	Sewing counter reaches set value	
M-071	The piece counter reaches the set value	Please press ok to clear
M-072	Successful	Current operation is successful!
M-073	Failed	Current operation is failed!
M-074	Fail to copy file	Please check the space in memory
M-075	Fail to copy file	Please check if the USB disk is pulled out!
M-076	File I/O error	File I/O error
M-077	Verification error when update main control program	
M-078	Can not delete pattern data.	The selected sewing data is being used
M-079	Whether to perform a parameter transfer operation	Yes: Enter No: X
M-080	Cannot open transformed pattern	Please confirm pattern
M-081	Wrong transformed pattern format	Please confirm pattern
M-082	Transformed pattern data is too long	Please confirm pattern
M-083	Update successful	Update is successful, please restart machine.
M-084	Fail to open file	Disk file open failed
M-085	Parameter recovery successful	Parameter recovery is successful, please restart machine
M-086	Not select update item	Please select item for updating. At least select one item
M-087	Some selected update items don't exist.	The item not existing will be cancelled after return. For updating the rest items, please confirm again
M-088	Format U Disk?	Press Enter to perform formatting operation. Press Esc to quit current operation. After formatting, all pattern files will be deleted.

		Press ok to perform the formatting operation, and press cancel to exit the current operation. All memory pattern data will be deleted after formatting!
M-089	Format memory or not	
M-090	Insufficient memory space	
M-091	This feature cannot be selected	
M-092	Draw the shape point repeatedly	
M-093	Cannot perform a fallback operation	
M-094	No next stitch sewing data	
M-095	No last stitch sewing data	
M-096	The pattern data is too large	
M-097	Abnormal operation	
M-098	General error in printing	
M-099	Patterns don't exist	
M-100	Out of range	
M-101	Beyond sewing range	Make sure pattern data is within sewing range
M-102	Stitch number beyond range	Please reduce stitch number
M-103	Error in pattern file data	
M-104	Confirmation point change	
M-105	Confirm automatic insertion of shear line	
M-106	Delete new edit pattern	Ok key confirm, exit key cancel
M-107	Delete elements	Ok key confirm, exit key cancel
M-108	Execute, confirm?	Ok key confirm, exit key cancel
M-109	Delete mechanical control command?	Ok key confirm, exit key cancel
M-110	Delete drop pin point	Ok key confirm, exit key cancel
M-111	Move the foot. Confirm?	Ok key confirm, exit key cancel
M-112	Delete shape point	Ok key confirm, exit key cancel
M-113	Warning: formatting will delete all data on disk!	Ok key confirm, exit key cancel
M-114	Please turn it off	The current operation has ended, please restart the machine
M-115	Disable counter	When modifying, turn off the Settings
M-116	Whether to restore factory Settings	Press Enter to perform or Cancel to quit the operation
M-117	Clear all custom parameters	Yes: Enter; No: X
M-118	Pattern calculation error	
M-119	Delete all P and C patterns	Press Enter to perform formatting operation. Press Esc to quit current operation
M-120	Beyond the set value	
M-121	Press foot on top	The current operation needs to be performed after the outer pressure foot is dropped!
M-122	Cannot operate correctly	

M-123	USB disk not exist	Please insert USB disk containing mps files
M-124	No video file video.avi	Please save the video.avi file into the update category of the U disk and then update the video file
M-125	Replace the bottom line	The set value of changing the bottom line has reached, please change the bottom line.
M-126	Determine clearance baseline count value?	Yes: Enter; No: X
M-127	Not enough bobbin thread	Please replace bobbin thread and press Enter to restart counting
M-128	Template pattern does not exist	Please exit, press the origin key and change the pattern
M-129	The pattern name file does not match the pattern	Press ok and reload. The more patterns, the longer it takes
M-130	Upgrade file length error	
M-131	Update master to erase validation errors	
M-132	Update master write check error	
M-133	Update master to end validation error	
M-134	Whether to save as new pattern	Ok key to perform operation, cancel key to exit operation When saved as a new pattern, the original pattern will not change.
M-135	Network connection failed	
M-136	Successful attendance check	
M-137	Unsuccessful attendance check	
M-138	Confirm the modification of the network function, please turn off the power and restart	The network function will be loaded after system restart
M-139	Oil box filling reminder	Please check the amount of oil in the oil container and fill it with appropriate oil
M-140	Grease maintenance reminder	Please check each maintenance part and add appropriate grease (please refer to the maintenance manual for specific operation).
M-141	Upgrade step end check error	
M-142	Correction reference point does not fall on the corresponding position on the pattern. Continued operation will cause the pattern to scale. Whether to continue operation	Press Enter to perform or Cancel to quit the operation
M-143	The seam starting point exceeds the safe position. The seam starting point cannot be modified	
M-144	The needle position in sewing is out of line with the pattern	

M-145	QR code display failed	
M-146	Grouping number invalid	
M-147	Current operation denied	
M-148	No parameter received	
M-149	Parameter not changed	
M-150	Operation panel and main control mismatch	There is periodical password, please contact manufacturer to unlock.
M-151	There is password for operation panel, synchronization is needed	Password for panel, but no password for main control
M-152	There is password for main control, synchronization is needed	Password for main control, but no password for panel
M-153	Main board ID not exist	
M-154	The panel is not encrypted. The master controls encryption	The system locks the machine
M-155	Panel encryption, master encryption	Determine the key synchronous encryption status
M-156	Remote staging Settings already exist on the system	Confirm the key to continue the operation, cancel the key to exit the operation
M-157	Wireless module 1 connection failed	System speed down to the minimum, please contact the manufacturer
M-158	The system has been set to disconnected mode	The networking function can be turned on for detection
M-159	A join failure	
M-160	Cannot perform replacement operation	At least one parameter and pattern should be selected
M-161	Replacement success	Parameter or pattern has successfully overwritten the machine. Shutdown and restart are required
M-162	Do you want to update the thumbnails now?	The pattern also generates thumbnails when used
M-163	The pattern does not exist, whether to download from the server	Yes: Enter; No: X
M-164	Request patterns are not standard VDT format	
M-165	There is no request pattern on the server	
M-166	Server update software, whether to upgrade operation	Yes: Enter; No: X
M-167	The request failed	
M-168	Verify that the user customization parameters are modified	Yes: Enter; No: X
M-169	Parameter modification takes effect and requires unlocking	Yes: Enter; No: X

9 Appendix 2

9.1 Connection diagram of electric cabinet

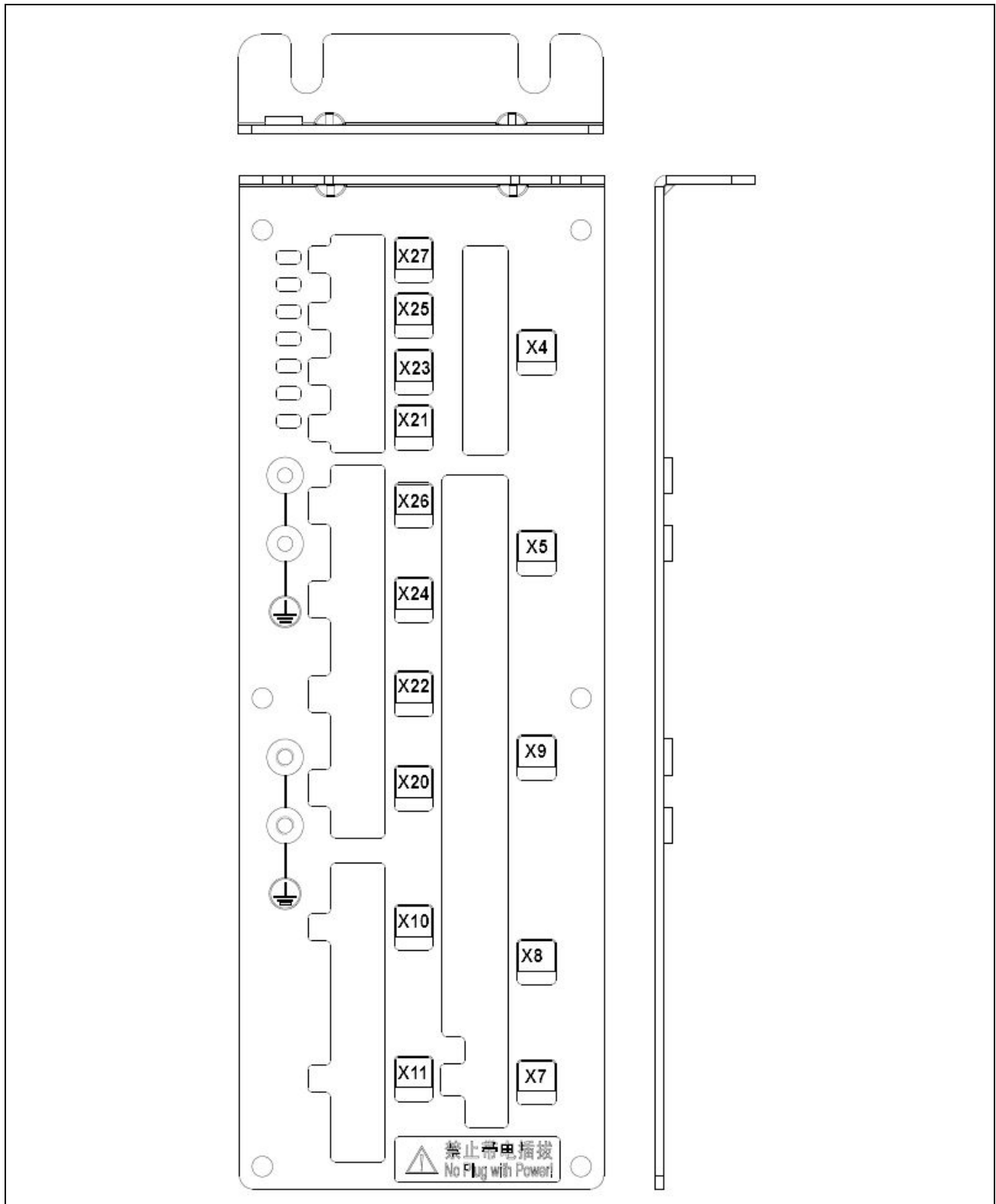

Figure 1 Connection diagram of electric cabinet

9.2 Schematic diagram of operation box

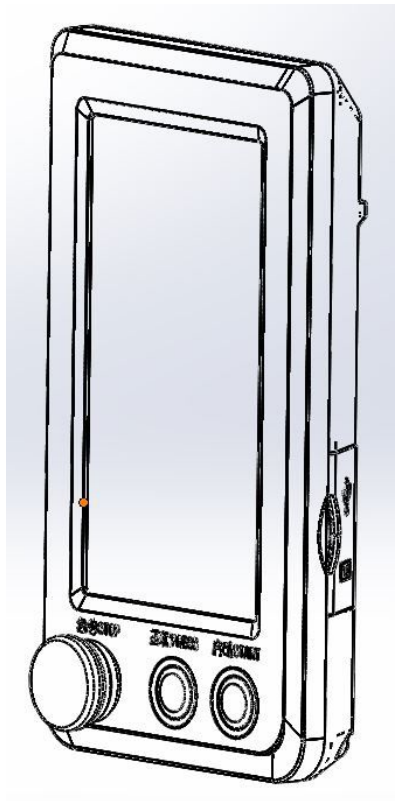

Figure 2 Schematic diagram of operation box

9.3 Control System Diagram

MHSC4056-2E2/B-MBJ

